

Data .....	Italia	
Utilizzatore .....	Timbro ditta	Carrozzina leggera pieghevole
Peso utilizzatore (kg) .....		
Lingua manuale d'uso .....	Responsabile .....	

**Misure carrozzina - La tolleranza su tutte le dimensioni indicate e/o richieste è di ± 10 mm**

Larghezza sedile (LS)	<input type="checkbox"/> 36 <input type="checkbox"/> 39 <input type="checkbox"/> 42 <input type="checkbox"/> 45		
<b>Larghezza sedile (LS) MAXI</b>	<input type="radio"/> 48	03025	<b>110,00</b>
<b>Con barra di irrigidimento schienale. - Disponibile solo Blu China</b>	<input type="radio"/> 51	04030	<b>110,00</b>
	<input type="radio"/> 54	04031	<b>110,00</b>
Profondità sedile (PS)	<input type="checkbox"/> 40 <input type="checkbox"/> 42,5 <input type="checkbox"/> 45		
<b>La profondità seduta effettiva misurata da inizio tela sedile a tubo schienale risulta maggiorata di 2 cm</b>			
Altezza schienale (TS)	Val.Standard 41 .....(min 27-max 47) step di regolazione 1,5cm		
<b>Schienale con regolazione dell'inclinazione da -6° a +6°</b>			
Assetto	<input checked="" type="checkbox"/> Standard <input type="checkbox"/> Arretrato per amputati		
Distanza pedana (DP)	..... (cm) ±0,5cm - step di regolazione 2cm		
<b>(Distanza tela sedile - piatto pedana) - ATTENZIONE! Altezza anteriore minimo 4 cm maggiore della DISTANZA PEDANA</b>			
Crociera doppia di serie			
<b>ALTEZZA ANTERIORE ..... (STD 50) - ALTEZZA POSTERIORE ..... (STD 45,5)</b>			

**Telaio**

<input checked="" type="checkbox"/> Telaio standard	<input type="checkbox"/> Blu China		
	<input type="checkbox"/> Rosso Perla	<b>(non disponibile per larghezza 45 e per larghezze MAXI 48, 51 e 54)</b>	
		<b>Fino ad esaurimento scorte</b>	



**Ruote anteriori**

<input checked="" type="checkbox"/> 6" Piena Soft			
<input type="checkbox"/> 4" Piena Soft		00010	<b>70,00</b>
<input type="checkbox"/> 5" Piena Soft		00832	<b>70,00</b>
<input type="checkbox"/> 5" Pneumatica		10844	<b>60,00</b>
<input type="checkbox"/> 6" Pneumatica		02107	<b>70,00</b>
<input type="checkbox"/> 7" Piena Soft		02108	<b>70,00</b>

**Ruote posteriori**

<input checked="" type="checkbox"/> Ruota posteriore da 24"			
<input type="checkbox"/> Ruota posteriore da 22"		03136	<b>220,00</b>
<input type="checkbox"/> 24" con freno a tamburo per accompagnatore (corrimano in alluminio)		03384	<b>350,00</b>
<input type="checkbox"/> Monoguida per emiplegici - (ruote da 24" corrimano in alluminio e copertone alta pressione tassellato)		02103	<b>390,00</b>
	<input type="radio"/> Destra		
	<input type="radio"/> Sinistra		
<input type="checkbox"/> Ruote da transito da 300	<b>H Post. fissa 45,5</b>	<input type="checkbox"/> Copertura piena <input type="checkbox"/> Pneumatica	02104 <b>110,00</b>
<input type="checkbox"/> Ruote da transito da 300 con freno a tamburo per accompagnatore	<b>H Post. fissa 45,5</b>	<input type="checkbox"/> Copertura piena <input type="checkbox"/> Pneumatica	02105 <b>340,00</b>

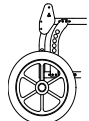

**Copertura ruota posteriore**

<input checked="" type="checkbox"/> Tassellato Alta Pressione	(24")		
<input type="checkbox"/> Liscio Alta Pressione	(22"-24")	00751	<b>60,00</b>
<input type="checkbox"/> Copertura piena - Colore Grigio	(22"-24")	04181	<b>110,00</b>

**Cerchi di spinta**

<input checked="" type="checkbox"/> Alluminio	Distanza ruota <input checked="" type="checkbox"/> 3 cm <input type="checkbox"/> 4 cm		
<input type="checkbox"/> Alluminio Nero SOFT-TOUCH	(24")	09170	<b>110,00</b>
<input type="checkbox"/> Acciaio cromato	(24")	01684	<b>170,00</b>
<input type="checkbox"/> Titanio	(24")	00016	<b>270,00</b>
<input type="checkbox"/> Ultra Grepp	(24")	00017	<b>300,00</b>
<input type="checkbox"/> TOP FRICTION	(24")	11023	<b>290,00</b>
Profilo ovale con inserto in gomma			
<input type="checkbox"/> NOVA H	(24")	11025	<b>270,00</b>
Profilo ergonomico colore nero			
<input type="checkbox"/> NOVA D	(24")	11026	<b>290,00</b>
Profilo ergonomico con rivestimento in gomma (ideale per tetraplegici)			
<input type="checkbox"/> Anello anti scivolo in silicone applicabile su cerchio in alluminio	Disponibile per misure da (22"-24")	04050	<b>170,00</b>

Permobil Progeo Active Design s.r.l. - a Socio Unico - Vicolo L. Negrelli, 5 - 31038 Paese (TV) - Tel. +39 0422 484657  
 P.IVA, Codice Fiscale e Numero di iscrizione al Registro Imprese di Treviso 10246110968 - Fatturazione Elettronica: Codice Destinatario A4707H7 - Capitale Sociale I.V. € 10.000,00

Email: info\_it@permobil.com - web: http://www.rehateamprogeo.com

Data .....	Commessa .....	Utilizzatore .....	Indirizzo .....
------------	----------------	--------------------	-----------------

**Optional su richiesta (SENZA AGGIUNTA DI PREZZO)**  
 RUOTE ANTIRIBALTAMENTO - RUOTE ASCENSORE - AIUTO RIBALTAMENTO

**Freni**

☆ Freno standard 01949 **70,00**

○ Freno con leva prolungata da spingere

**Pedana - Vedi Tabelle di Riferimento N°3**

☆ Pedana sdoppiata in plastica, regolabile in inclinazione  
 Distanza pedana minima possibile 29cm.      Sistema di unione - di serie per MAXI 48-51-54 11525

○ Pedana unica alzabile regolabile in profondità e inclinazione  
 Distanza pedana minima possibile 27cm.       interna    ☆ 2/3 interna     esterna 01533 **220,00**  
 (non disponibile per larghezze MAXI 48, 51 e 54)

○ Sistema multifunzione rotativo - Distanza pedana minima possibile 22cm. 03945 **180,00**

○ Pedana unica alzabile in alluminio regolabile in profondità e inclinazione  
 Distanza pedana minima possibile 27cm.       interna    ☆ 2/3 interna     2/3 esterna     esterna 04099 **220,00**  
 (non disponibile per larghezze MAXI 48, 51 e 54)

○ Pedane elevabili  
 Distanza pedana minima possibile 34cm. 04095 **200,00**

**Braccioli**

☆ Braccioli Desk PROGEO (Estraibili regolabili in altezza)  
 Braccioli estraibili CON protezione vestiario integrata

○ Braccioli Tubolari (Estraibili regolabili in altezza con parafanghi in ABS) 00009 **290,00**

**Accessori**

○ Imbottitura paracolpi telaio anteriore 07058 **50,00**

○ Borsello portaoggetti removibile (con aggancio rapido) 09811 **120,00**

**Optional**

○ Maniglie di spinta per accompagnatore (Regolabili in altezza ed estraibili) 01048 **190,00**

○ Cinghia pelvica di ancoraggio 03972 **70,00**

○ Cinghia di bretellaggio 04103 **130,00**

○ Tavolino (estraibile) 00508 **260,00**

○ Poggiatesta Super Head Multiadattabile (sistema pieghevole con la carrozzina) 04049 **400,00**

**Optional**

○ Porta stampelle  Destro 00838 **80,00**  
 Sinistro 00837 **80,00**

○ Spinta laterale  Destra 02097 **250,00**  
 Non disponibile con Schienale posturale PHYSIO  Sinistra 02098 **250,00**

○ Copriragghi Nero (22"-24") 01043 **160,00**

○ Copriragghi Trasparente (22"-24") 00835 **160,00**

○ Copriragghi Colorato Progeo Design (22"-24") 00019 **180,00**

**Kit aggiuntivo**

○ Ruote posteriori 24" Fuoristrada Copertone Fuoristrada - corrimano in alluminio (colore nero) 03378 **500,00**

○ Ruote posteriori FAT 24" Copertone liscio FAT 3" - corrimano in alluminio (colore nero) 09357 **850,00**

Permobil Progeo Active Design s.r.l. - a Socio Unico - Vicolo L. Negrilli, 5 - 31038 Paese (TV) - Tel. +39 0422 484657  
 P.IVA, Codice Fiscale e Numero di iscrizione al Registro Imprese di Treviso 10246110968 - Fatturazione Elettronica: Codice Destinatario A4707H7 - Capitale Sociale I.V. € 10.000,00

Email: info\_it@permobil.com - web: http://www.rehateamprogeo.com

Data ..... Commessa ..... Utilizzatore ..... Indirizzo .....

**PHYSIO - Schienale posturale**  
**(Imbottitura schienale originale non fornita)**

Estraibile con aggancio rapido  
Installazione su tubi diametro 18÷26mm  
Regolazione in profondità (4cm)  
Regolazione inclinazione (±18°)

- AIR** Guscio CARBONIO  
non disponibile per larghezza 48, 51, 54

ALTEZZA SCHIENALE	28	34	40			
Conformazione del guscio 	Ala di contenimento laterale A=alta - R=regolare					
	A	R	A	R	A	R
	<input type="checkbox"/>	<input type="checkbox"/>	<input type="checkbox"/>	<input type="checkbox"/>	<input type="checkbox"/>	<input type="checkbox"/>

860,00

- POSTURE** Guscio ALLUMINIO  
non disponibile per larghezza 54

ALTEZZA SCHIENALE	34	40	52
Conformazione del guscio 	Ala di contenimento laterale R=regolare		
	R	R	R
	<input type="checkbox"/>	<input type="checkbox"/>	<input type="checkbox"/>

830,00

**Configurazione DEEP con PAD per contenimento laterale (regolabili in altezza)**

Pad in alluminio con imbottitura e rivestimento in tessuto traspirante



Piccolo (h 13cm)



- Destro  
10272

40,00

- Sinistro  
10272

40,00

Grande (h 20cm)



- Destro  
10273

50,00

- Sinistro  
10273

50,00

**Supporti toracici (spinta laterale) - SWING AWAY - Girevole**

Hardware di fissaggio e regolazione completi di imbottitura paracolpi  
Pad in alluminio con imbottitura e rivestimento in tessuto traspirante

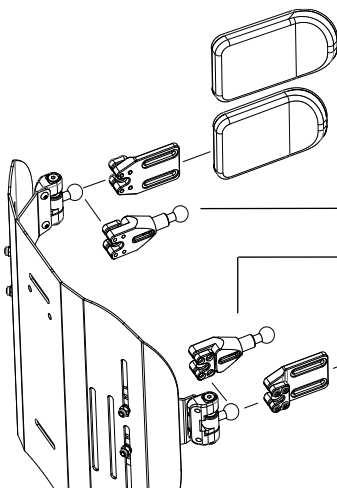

- Grande (18x12)

05647 170,00

- Piccola (14x9)

05643 170,00

- Prolunga supporto toracico

Quantità (n° pz).....

10271 60,00

- Prolunga supporto toracico

Quantità (n° pz).....

- Piccola (14x9)

05642 170,00

- Grande (18x12)

05646 170,00





- Poggiatesta multiregolazione - sistema di montaggio a doppia sfera  
Disponibile solo su schienale Physio Posture



- Grande (35x12,5)  
 Piccolo (25x12,5)

05648 360,00

Data .....	Commessa .....	Utilizzatore .....	Indirizzo .....
------------	----------------	--------------------	-----------------

<b>Cuscini antidecubito e posturali a nido d'ape STIMULITE</b>						
<input type="radio"/> Classic H 7 cm.	<input type="checkbox"/> 36x41 00035 <input type="checkbox"/> 41x46 00840	<input type="checkbox"/> 38x38 00036 <input type="checkbox"/> 46x41 00698	<input type="checkbox"/> 38x41 01052 <input type="checkbox"/> 46x46 00038	<input type="checkbox"/> 41x41 00037		<b>630,00</b>
<input type="radio"/> Anatomico Posturale H 9 cm. H 5cm. nella zona ischiatica	<input type="checkbox"/> 36x41 00056 <input type="checkbox"/> 41x46 01050	<input type="checkbox"/> 38x38 00696 <input type="checkbox"/> 46x41 00034	<input type="checkbox"/> 38x41 00032 <input type="checkbox"/> 46x46 01051	<input type="checkbox"/> 41x41 00033		<b>630,00</b>
<input type="radio"/> Slimline sagomato H 7 cm. H 5cm. nella zona ischiatica	<input type="checkbox"/> 36x41 00854 <input type="checkbox"/> 41x46 00085	<input type="checkbox"/> 38x38 00707 <input type="checkbox"/> 46x41 01074	<input type="checkbox"/> 38x41 00083 <input type="checkbox"/> 46x46 01075	<input type="checkbox"/> 41x41 01073		<b>630,00</b>
<input type="radio"/> Sport H 5 cm.	<input type="checkbox"/> 36x41 00053 <input type="checkbox"/> 41x46 00057	<input type="checkbox"/> 38x38 00054 <input type="checkbox"/> 46x41 01062	<input type="checkbox"/> 38x41 01060 <input type="checkbox"/> 46x46 00846	<input type="checkbox"/> 41x41 01061		<b>630,00</b>
<input type="radio"/> Silver H 3,5 cm.	<input type="checkbox"/> 41x41 00641	<input type="checkbox"/> 41x46 01353	<input type="checkbox"/> 46x41 00642	<input type="checkbox"/> 46x46 01022		<b>630,00</b>
Misura cliente		Larghezza cm. ....		Profondità cm. ....		

<input type="radio"/> Supporto lombare STIMULITE		00064 <b>220,00</b>
--	--	---------------------

Note

Carrozzina : Progeo BASIC LIGHT - Rev. 2026.0	Prezzo IVA esclusa da sommare al prezzo di listino	<b>Pagina da inviare se sono stati scelti optional</b> <input checked="" type="checkbox"/> standard (fornito in assenza di altre indicazioni) <input type="checkbox"/> su richiesta (senza aggiunta di prezzo) <input type="radio"/> optional (sommare il prezzo a quello di listino)
---	---	--

Permobili Progeo Active Design s.r.l. - a Socio Unico - Vicolo L. Negrelli, 5 - 31038 Paese (TV) - Tel. +39 0422 484657  
 P.IVA, Codice Fiscale e Numero di iscrizione al Registro Imprese di Treviso 10246110968 - Fatturazione Elettronica: Codice Destinatario A4707H7 - Capitale Sociale I.V. € 10.000,00







Email: info\_it@permobili.com - web: http://www.rehateamprogeo.com

## TABELLE DI RIFERIMENTO

1	ALTEZZA ANTERIORE	
	Ruote anteriori	ALTEZZA ANTERIORE min.      max
4"	40	50
5"	41	51
6"	44	52
7"	47	53

2	Telaio Posteriore Standard	
	Ruote posteriori	ALTEZZA POSTERIORE min.      max.
22"	35,5	50,5
24"	38	53

3	Tipo Pedana	Distanza pedana
	Pedana sdoppiata in plastica	min. 29
	Pedana unica alzabile	min. 27
	Pedana unica alzabile in alluminio regolabile in profondità e inclinazione	min. 27
	Pedane elevabili	min. 34
<b>Calcolate in conformazioni ideali e con pedane nella posizione interna</b>		
<b>ATTENZIONE! Altezza anteriore minimo 4 cm maggiore della DISTANZA PEDANA</b>		

Data	Commessa	Utilizzatore	Indirizzo																																																																								
<b>ROHO® MOSAIC® - H7cm - Limite di peso 143Kg</b> <span style="float: right;"><b>200,00</b></span>																																																																											
<table border="1"> <thead> <tr> <th>Misure cuscino LxP</th> <th>Adatto a seduta LSxPS</th> <th>Codice</th> </tr> </thead> <tbody> <tr><td><input type="checkbox"/> 41 x 41</td><td>42 x 42</td><td>MOS1616HD</td></tr> <tr><td><input type="checkbox"/> 41 x 46</td><td>42 x 47</td><td>MOS1618HD</td></tr> <tr><td><input type="checkbox"/> 44 x 44</td><td>44 x 44</td><td>MOS1717HD</td></tr> </tbody> </table>	Misure cuscino LxP	Adatto a seduta LSxPS	Codice	<input type="checkbox"/> 41 x 41	42 x 42	MOS1616HD	<input type="checkbox"/> 41 x 46	42 x 47	MOS1618HD	<input type="checkbox"/> 44 x 44	44 x 44	MOS1717HD	<table border="1"> <thead> <tr> <th>Misure cuscino LxP</th> <th>Adatto a seduta LSxPS</th> <th>Codice</th> </tr> </thead> <tbody> <tr><td><input type="checkbox"/> 46 x 41</td><td>47 x 42</td><td>MOS1816HD</td></tr> <tr><td><input type="checkbox"/> 46 x 46</td><td>47 x 47</td><td>MOS1818HD</td></tr> <tr><td><input type="checkbox"/> 51 x 46</td><td>52 x 47</td><td>MOS2018HD</td></tr> </tbody> </table>	Misure cuscino LxP	Adatto a seduta LSxPS	Codice	<input type="checkbox"/> 46 x 41	47 x 42	MOS1816HD	<input type="checkbox"/> 46 x 46	47 x 47	MOS1818HD	<input type="checkbox"/> 51 x 46	52 x 47	MOS2018HD																																																		
Misure cuscino LxP	Adatto a seduta LSxPS	Codice																																																																									
<input type="checkbox"/> 41 x 41	42 x 42	MOS1616HD																																																																									
<input type="checkbox"/> 41 x 46	42 x 47	MOS1618HD																																																																									
<input type="checkbox"/> 44 x 44	44 x 44	MOS1717HD																																																																									
Misure cuscino LxP	Adatto a seduta LSxPS	Codice																																																																									
<input type="checkbox"/> 46 x 41	47 x 42	MOS1816HD																																																																									
<input type="checkbox"/> 46 x 46	47 x 47	MOS1818HD																																																																									
<input type="checkbox"/> 51 x 46	52 x 47	MOS2018HD																																																																									
<b>ROHO® AIR LITE® - H9,5cm - Limite di peso 136Kg</b> <span style="float: right;"><b>200,00</b></span>																																																																											
<table border="1"> <thead> <tr> <th>Misure cuscino LxP</th> <th>Codice</th> </tr> </thead> <tbody> <tr><td><input type="checkbox"/> 33 x 33</td><td>AL1313HD</td></tr> <tr><td><input type="checkbox"/> 33 x 38</td><td>AL1315HD</td></tr> <tr><td><input type="checkbox"/> 36 x 36</td><td>AL1414HD</td></tr> <tr><td><input type="checkbox"/> 36 x 41</td><td>AL1416HD</td></tr> <tr><td><input type="checkbox"/> 38 x 38</td><td>AL1515HD</td></tr> <tr><td><input type="checkbox"/> 38 x 43</td><td>AL1517HD</td></tr> <tr><td><input type="checkbox"/> 41 x 41</td><td>AL1616HD</td></tr> <tr><td><input type="checkbox"/> 41 x 46</td><td>AL1618HD</td></tr> <tr><td><input type="checkbox"/> 43 x 43</td><td>AL1717HD</td></tr> </tbody> </table>	Misure cuscino LxP	Codice	<input type="checkbox"/> 33 x 33	AL1313HD	<input type="checkbox"/> 33 x 38	AL1315HD	<input type="checkbox"/> 36 x 36	AL1414HD	<input type="checkbox"/> 36 x 41	AL1416HD	<input type="checkbox"/> 38 x 38	AL1515HD	<input type="checkbox"/> 38 x 43	AL1517HD	<input type="checkbox"/> 41 x 41	AL1616HD	<input type="checkbox"/> 41 x 46	AL1618HD	<input type="checkbox"/> 43 x 43	AL1717HD	<table border="1"> <thead> <tr> <th>Misure cuscino LxP</th> <th>Codice</th> </tr> </thead> <tbody> <tr><td><input type="checkbox"/> 43 x 46</td><td>AL1718HD</td></tr> <tr><td><input type="checkbox"/> 43 x 51</td><td>AL1720HD</td></tr> <tr><td><input type="checkbox"/> 46 x 41</td><td>AL1816HD</td></tr> <tr><td><input type="checkbox"/> 46 x 46</td><td>AL1818HD</td></tr> <tr><td><input type="checkbox"/> 46 x 51</td><td>AL1820HD</td></tr> <tr><td><input type="checkbox"/> 48 x 43</td><td>AL1917HD</td></tr> <tr><td><input type="checkbox"/> 48 x 48</td><td>AL1919HD</td></tr> <tr><td><input type="checkbox"/> 51 x 43</td><td>AL2017HD</td></tr> <tr><td><input type="checkbox"/> 51 x 46</td><td>AL2018HD</td></tr> </tbody> </table>	Misure cuscino LxP	Codice	<input type="checkbox"/> 43 x 46	AL1718HD	<input type="checkbox"/> 43 x 51	AL1720HD	<input type="checkbox"/> 46 x 41	AL1816HD	<input type="checkbox"/> 46 x 46	AL1818HD	<input type="checkbox"/> 46 x 51	AL1820HD	<input type="checkbox"/> 48 x 43	AL1917HD	<input type="checkbox"/> 48 x 48	AL1919HD	<input type="checkbox"/> 51 x 43	AL2017HD	<input type="checkbox"/> 51 x 46	AL2018HD																																		
Misure cuscino LxP	Codice																																																																										
<input type="checkbox"/> 33 x 33	AL1313HD																																																																										
<input type="checkbox"/> 33 x 38	AL1315HD																																																																										
<input type="checkbox"/> 36 x 36	AL1414HD																																																																										
<input type="checkbox"/> 36 x 41	AL1416HD																																																																										
<input type="checkbox"/> 38 x 38	AL1515HD																																																																										
<input type="checkbox"/> 38 x 43	AL1517HD																																																																										
<input type="checkbox"/> 41 x 41	AL1616HD																																																																										
<input type="checkbox"/> 41 x 46	AL1618HD																																																																										
<input type="checkbox"/> 43 x 43	AL1717HD																																																																										
Misure cuscino LxP	Codice																																																																										
<input type="checkbox"/> 43 x 46	AL1718HD																																																																										
<input type="checkbox"/> 43 x 51	AL1720HD																																																																										
<input type="checkbox"/> 46 x 41	AL1816HD																																																																										
<input type="checkbox"/> 46 x 46	AL1818HD																																																																										
<input type="checkbox"/> 46 x 51	AL1820HD																																																																										
<input type="checkbox"/> 48 x 43	AL1917HD																																																																										
<input type="checkbox"/> 48 x 48	AL1919HD																																																																										
<input type="checkbox"/> 51 x 43	AL2017HD																																																																										
<input type="checkbox"/> 51 x 46	AL2018HD																																																																										
<b>ROHO® HYBRID ELITE SR® - Monovalvola - Sensor Ready - Limite di peso 225Kg</b> <span style="float: right;"><b>630,00</b></span>																																																																											
<table border="1"> <thead> <tr> <th>Misure cuscino LxP</th> <th>Adatto a seduta LSxPS</th> <th>Codice</th> </tr> </thead> <tbody> <tr><td><input type="checkbox"/> 35 x 37,5</td><td>36 x 36</td><td>1RHE1414C-SR</td></tr> <tr><td><input type="checkbox"/> 35 x 40</td><td>36 x 38</td><td>1RHE1415C-SR</td></tr> <tr><td><input type="checkbox"/> 35 x 43</td><td>36 x 41</td><td>1RHE1416C-SR</td></tr> <tr><td><input type="checkbox"/> 37,5 x 40</td><td>38 x 38</td><td>1RHE1515C-SR</td></tr> <tr><td><input type="checkbox"/> 37,5 x 43</td><td>38 x 41</td><td>1RHE1516C-SR</td></tr> <tr><td><input type="checkbox"/> 37,5 x 45</td><td>38 x 43</td><td>1RHE1517C-SR</td></tr> <tr><td><input type="checkbox"/> 40 x 40</td><td>41 x 38</td><td>1RHE1615C-SR</td></tr> <tr><td><input type="checkbox"/> 40 x 43</td><td>41 x 41</td><td>1RHE1616C-SR</td></tr> <tr><td><input type="checkbox"/> 40 x 45</td><td>41 x 43</td><td>1RHE1617C-SR</td></tr> <tr><td><input type="checkbox"/> 40 x 48</td><td>41 x 46</td><td>1RHE1618C-SR</td></tr> <tr><td><input type="checkbox"/> 40 x 53</td><td>41 x 51</td><td>1RHE1620C-SR</td></tr> </tbody> </table>	Misure cuscino LxP	Adatto a seduta LSxPS	Codice	<input type="checkbox"/> 35 x 37,5	36 x 36	1RHE1414C-SR	<input type="checkbox"/> 35 x 40	36 x 38	1RHE1415C-SR	<input type="checkbox"/> 35 x 43	36 x 41	1RHE1416C-SR	<input type="checkbox"/> 37,5 x 40	38 x 38	1RHE1515C-SR	<input type="checkbox"/> 37,5 x 43	38 x 41	1RHE1516C-SR	<input type="checkbox"/> 37,5 x 45	38 x 43	1RHE1517C-SR	<input type="checkbox"/> 40 x 40	41 x 38	1RHE1615C-SR	<input type="checkbox"/> 40 x 43	41 x 41	1RHE1616C-SR	<input type="checkbox"/> 40 x 45	41 x 43	1RHE1617C-SR	<input type="checkbox"/> 40 x 48	41 x 46	1RHE1618C-SR	<input type="checkbox"/> 40 x 53	41 x 51	1RHE1620C-SR	<table border="1"> <thead> <tr> <th>Misure cuscino LxP</th> <th>Adatto a seduta LSxPS</th> <th>Codice</th> </tr> </thead> <tbody> <tr><td><input type="checkbox"/> 43 x 43</td><td>43 x 41</td><td>1RHE1716C-SR</td></tr> <tr><td><input type="checkbox"/> 43 x 45</td><td>43 x 43</td><td>1RHE1717C-SR</td></tr> <tr><td><input type="checkbox"/> 43 x 48</td><td>43 x 46</td><td>1RHE1718C-SR</td></tr> <tr><td><input type="checkbox"/> 43 x 53</td><td>43 x 51</td><td>1RHE1720C-SR</td></tr> <tr><td><input type="checkbox"/> 45 x 43</td><td>46 x 41</td><td>1RHE1816C-SR</td></tr> <tr><td><input type="checkbox"/> 45 x 45</td><td>46 x 43</td><td>1RHE1817C-SR</td></tr> <tr><td><input type="checkbox"/> 45 x 48</td><td>46 x 46</td><td>1RHE1818C-SR</td></tr> <tr><td><input type="checkbox"/> 45 x 53</td><td>46 x 51</td><td>1RHE1820C-SR</td></tr> <tr><td><input type="checkbox"/> 50 x 45</td><td>51 x 43</td><td>1RHE2017C-SR</td></tr> <tr><td><input type="checkbox"/> 50 x 48</td><td>51 x 46</td><td>1RHE2018C-SR</td></tr> <tr><td><input type="checkbox"/> 50 x 53</td><td>51 x 51</td><td>1RHE2020C-SR</td></tr> </tbody> </table>	Misure cuscino LxP	Adatto a seduta LSxPS	Codice	<input type="checkbox"/> 43 x 43	43 x 41	1RHE1716C-SR	<input type="checkbox"/> 43 x 45	43 x 43	1RHE1717C-SR	<input type="checkbox"/> 43 x 48	43 x 46	1RHE1718C-SR	<input type="checkbox"/> 43 x 53	43 x 51	1RHE1720C-SR	<input type="checkbox"/> 45 x 43	46 x 41	1RHE1816C-SR	<input type="checkbox"/> 45 x 45	46 x 43	1RHE1817C-SR	<input type="checkbox"/> 45 x 48	46 x 46	1RHE1818C-SR	<input type="checkbox"/> 45 x 53	46 x 51	1RHE1820C-SR	<input type="checkbox"/> 50 x 45	51 x 43	1RHE2017C-SR	<input type="checkbox"/> 50 x 48	51 x 46	1RHE2018C-SR	<input type="checkbox"/> 50 x 53	51 x 51	1RHE2020C-SR		
Misure cuscino LxP	Adatto a seduta LSxPS	Codice																																																																									
<input type="checkbox"/> 35 x 37,5	36 x 36	1RHE1414C-SR																																																																									
<input type="checkbox"/> 35 x 40	36 x 38	1RHE1415C-SR																																																																									
<input type="checkbox"/> 35 x 43	36 x 41	1RHE1416C-SR																																																																									
<input type="checkbox"/> 37,5 x 40	38 x 38	1RHE1515C-SR																																																																									
<input type="checkbox"/> 37,5 x 43	38 x 41	1RHE1516C-SR																																																																									
<input type="checkbox"/> 37,5 x 45	38 x 43	1RHE1517C-SR																																																																									
<input type="checkbox"/> 40 x 40	41 x 38	1RHE1615C-SR																																																																									
<input type="checkbox"/> 40 x 43	41 x 41	1RHE1616C-SR																																																																									
<input type="checkbox"/> 40 x 45	41 x 43	1RHE1617C-SR																																																																									
<input type="checkbox"/> 40 x 48	41 x 46	1RHE1618C-SR																																																																									
<input type="checkbox"/> 40 x 53	41 x 51	1RHE1620C-SR																																																																									
Misure cuscino LxP	Adatto a seduta LSxPS	Codice																																																																									
<input type="checkbox"/> 43 x 43	43 x 41	1RHE1716C-SR																																																																									
<input type="checkbox"/> 43 x 45	43 x 43	1RHE1717C-SR																																																																									
<input type="checkbox"/> 43 x 48	43 x 46	1RHE1718C-SR																																																																									
<input type="checkbox"/> 43 x 53	43 x 51	1RHE1720C-SR																																																																									
<input type="checkbox"/> 45 x 43	46 x 41	1RHE1816C-SR																																																																									
<input type="checkbox"/> 45 x 45	46 x 43	1RHE1817C-SR																																																																									
<input type="checkbox"/> 45 x 48	46 x 46	1RHE1818C-SR																																																																									
<input type="checkbox"/> 45 x 53	46 x 51	1RHE1820C-SR																																																																									
<input type="checkbox"/> 50 x 45	51 x 43	1RHE2017C-SR																																																																									
<input type="checkbox"/> 50 x 48	51 x 46	1RHE2018C-SR																																																																									
<input type="checkbox"/> 50 x 53	51 x 51	1RHE2020C-SR																																																																									
<b>ROHO® HYBRID ELITE® - Bivalvola /Bicompartimento - Limite di peso 225Kg</b> <span style="float: right;"><b>630,00</b></span>																																																																											
<table border="1"> <thead> <tr> <th>Misure cuscino LxP</th> <th>Adatto a seduta LSxPS</th> <th>Codice</th> </tr> </thead> <tbody> <tr><td><input type="checkbox"/> 35 x 37,5</td><td>36 x 36</td><td>2RHE1414C</td></tr> <tr><td><input type="checkbox"/> 35 x 40</td><td>36 x 38</td><td>2RHE1415C</td></tr> <tr><td><input type="checkbox"/> 35 x 43</td><td>36 x 41</td><td>2RHE1416C</td></tr> <tr><td><input type="checkbox"/> 37,5 x 40</td><td>38 x 38</td><td>2RHE1515C</td></tr> <tr><td><input type="checkbox"/> 37,5 x 43</td><td>38 x 41</td><td>2RHE1516C</td></tr> <tr><td><input type="checkbox"/> 37,5 x 45</td><td>38 x 43</td><td>2RHE1517C</td></tr> <tr><td><input type="checkbox"/> 40 x 40</td><td>41 x 38</td><td>2RHE1615C</td></tr> <tr><td><input type="checkbox"/> 40 x 43</td><td>41 x 41</td><td>2RHE1616C</td></tr> <tr><td><input type="checkbox"/> 40 x 45</td><td>41 x 43</td><td>2RHE1617C</td></tr> <tr><td><input type="checkbox"/> 40 x 48</td><td>41 x 46</td><td>2RHE1618C</td></tr> <tr><td><input type="checkbox"/> 40 x 53</td><td>41 x 51</td><td>2RHE1620C</td></tr> </tbody> </table>	Misure cuscino LxP	Adatto a seduta LSxPS	Codice	<input type="checkbox"/> 35 x 37,5	36 x 36	2RHE1414C	<input type="checkbox"/> 35 x 40	36 x 38	2RHE1415C	<input type="checkbox"/> 35 x 43	36 x 41	2RHE1416C	<input type="checkbox"/> 37,5 x 40	38 x 38	2RHE1515C	<input type="checkbox"/> 37,5 x 43	38 x 41	2RHE1516C	<input type="checkbox"/> 37,5 x 45	38 x 43	2RHE1517C	<input type="checkbox"/> 40 x 40	41 x 38	2RHE1615C	<input type="checkbox"/> 40 x 43	41 x 41	2RHE1616C	<input type="checkbox"/> 40 x 45	41 x 43	2RHE1617C	<input type="checkbox"/> 40 x 48	41 x 46	2RHE1618C	<input type="checkbox"/> 40 x 53	41 x 51	2RHE1620C	<table border="1"> <thead> <tr> <th>Misure cuscino LxP</th> <th>Adatto a seduta LSxPS</th> <th>Codice</th> </tr> </thead> <tbody> <tr><td><input type="checkbox"/> 43 x 43</td><td>43 x 41</td><td>2RHE1716C</td></tr> <tr><td><input type="checkbox"/> 43 x 45</td><td>43 x 43</td><td>2RHE1717C</td></tr> <tr><td><input type="checkbox"/> 43 x 48</td><td>43 x 46</td><td>2RHE1718C</td></tr> <tr><td><input type="checkbox"/> 43 x 53</td><td>43 x 51</td><td>2RHE1720C</td></tr> <tr><td><input type="checkbox"/> 45 x 43</td><td>46 x 41</td><td>2RHE1816C</td></tr> <tr><td><input type="checkbox"/> 45 x 45</td><td>46 x 43</td><td>2RHE1817C</td></tr> <tr><td><input type="checkbox"/> 45 x 48</td><td>46 x 46</td><td>2RHE1818C</td></tr> <tr><td><input type="checkbox"/> 45 x 53</td><td>46 x 51</td><td>2RHE1820C</td></tr> <tr><td><input type="checkbox"/> 50 x 45</td><td>51 x 43</td><td>2RHE2017C</td></tr> <tr><td><input type="checkbox"/> 50 x 48</td><td>51 x 46</td><td>2RHE2018C</td></tr> <tr><td><input type="checkbox"/> 50 x 53</td><td>51 x 51</td><td>2RHE2020C</td></tr> </tbody> </table>	Misure cuscino LxP	Adatto a seduta LSxPS	Codice	<input type="checkbox"/> 43 x 43	43 x 41	2RHE1716C	<input type="checkbox"/> 43 x 45	43 x 43	2RHE1717C	<input type="checkbox"/> 43 x 48	43 x 46	2RHE1718C	<input type="checkbox"/> 43 x 53	43 x 51	2RHE1720C	<input type="checkbox"/> 45 x 43	46 x 41	2RHE1816C	<input type="checkbox"/> 45 x 45	46 x 43	2RHE1817C	<input type="checkbox"/> 45 x 48	46 x 46	2RHE1818C	<input type="checkbox"/> 45 x 53	46 x 51	2RHE1820C	<input type="checkbox"/> 50 x 45	51 x 43	2RHE2017C	<input type="checkbox"/> 50 x 48	51 x 46	2RHE2018C	<input type="checkbox"/> 50 x 53	51 x 51	2RHE2020C		
Misure cuscino LxP	Adatto a seduta LSxPS	Codice																																																																									
<input type="checkbox"/> 35 x 37,5	36 x 36	2RHE1414C																																																																									
<input type="checkbox"/> 35 x 40	36 x 38	2RHE1415C																																																																									
<input type="checkbox"/> 35 x 43	36 x 41	2RHE1416C																																																																									
<input type="checkbox"/> 37,5 x 40	38 x 38	2RHE1515C																																																																									
<input type="checkbox"/> 37,5 x 43	38 x 41	2RHE1516C																																																																									
<input type="checkbox"/> 37,5 x 45	38 x 43	2RHE1517C																																																																									
<input type="checkbox"/> 40 x 40	41 x 38	2RHE1615C																																																																									
<input type="checkbox"/> 40 x 43	41 x 41	2RHE1616C																																																																									
<input type="checkbox"/> 40 x 45	41 x 43	2RHE1617C																																																																									
<input type="checkbox"/> 40 x 48	41 x 46	2RHE1618C																																																																									
<input type="checkbox"/> 40 x 53	41 x 51	2RHE1620C																																																																									
Misure cuscino LxP	Adatto a seduta LSxPS	Codice																																																																									
<input type="checkbox"/> 43 x 43	43 x 41	2RHE1716C																																																																									
<input type="checkbox"/> 43 x 45	43 x 43	2RHE1717C																																																																									
<input type="checkbox"/> 43 x 48	43 x 46	2RHE1718C																																																																									
<input type="checkbox"/> 43 x 53	43 x 51	2RHE1720C																																																																									
<input type="checkbox"/> 45 x 43	46 x 41	2RHE1816C																																																																									
<input type="checkbox"/> 45 x 45	46 x 43	2RHE1817C																																																																									
<input type="checkbox"/> 45 x 48	46 x 46	2RHE1818C																																																																									
<input type="checkbox"/> 45 x 53	46 x 51	2RHE1820C																																																																									
<input type="checkbox"/> 50 x 45	51 x 43	2RHE2017C																																																																									
<input type="checkbox"/> 50 x 48	51 x 46	2RHE2018C																																																																									
<input type="checkbox"/> 50 x 53	51 x 51	2RHE2020C																																																																									
<b>ROHO® HYBRID SELECT®</b> <span style="float: right;"><b>630,00</b></span>																																																																											
<table border="1"> <thead> <tr> <th>Misure cuscino LxP</th> <th>Adatto a seduta LSxPS</th> <th>Codice</th> </tr> </thead> <tbody> <tr><td><input type="checkbox"/> 35,5 x 37,5</td><td>36x38</td><td>HS1414C</td></tr> <tr><td><input type="checkbox"/> 35,5 x 42,5</td><td>36x43</td><td>HS1416C</td></tr> <tr><td><input type="checkbox"/> 38 x 40</td><td>38x40</td><td>HS1515C</td></tr> <tr><td><input type="checkbox"/> 38 x 42,5</td><td>38x43</td><td>HS1516C</td></tr> <tr><td><input type="checkbox"/> 38 x 45</td><td>38x45</td><td>HS1517C</td></tr> <tr><td><input type="checkbox"/> 40,5 x 40</td><td>41x40</td><td>HS1615C</td></tr> <tr><td><input type="checkbox"/> 40,5 x 42,5</td><td>41x43</td><td>HS1616C</td></tr> <tr><td><input type="checkbox"/> 40,5 x 45</td><td>41x45</td><td>HS1617C</td></tr> <tr><td><input type="checkbox"/> 40,5 x 47,5</td><td>41x48</td><td>HS1618C</td></tr> <tr><td><input type="checkbox"/> 40,5 x 52,5</td><td>41x53</td><td>HS1620C</td></tr> <tr><td><input type="checkbox"/> 43 x 42,5</td><td>43x43</td><td>HS1716C</td></tr> </tbody> </table>	Misure cuscino LxP	Adatto a seduta LSxPS	Codice	<input type="checkbox"/> 35,5 x 37,5	36x38	HS1414C	<input type="checkbox"/> 35,5 x 42,5	36x43	HS1416C	<input type="checkbox"/> 38 x 40	38x40	HS1515C	<input type="checkbox"/> 38 x 42,5	38x43	HS1516C	<input type="checkbox"/> 38 x 45	38x45	HS1517C	<input type="checkbox"/> 40,5 x 40	41x40	HS1615C	<input type="checkbox"/> 40,5 x 42,5	41x43	HS1616C	<input type="checkbox"/> 40,5 x 45	41x45	HS1617C	<input type="checkbox"/> 40,5 x 47,5	41x48	HS1618C	<input type="checkbox"/> 40,5 x 52,5	41x53	HS1620C	<input type="checkbox"/> 43 x 42,5	43x43	HS1716C	<table border="1"> <thead> <tr> <th>Misure cuscino LxP</th> <th>Adatto a seduta LSxPS</th> <th>Codice</th> </tr> </thead> <tbody> <tr><td><input type="checkbox"/> 43 x 45</td><td>43x45</td><td>HS1717C</td></tr> <tr><td><input type="checkbox"/> 43 x 47,5</td><td>43x48</td><td>HS1718C</td></tr> <tr><td><input type="checkbox"/> 43 x 52,5</td><td>43x53</td><td>HS1720C</td></tr> <tr><td><input type="checkbox"/> 45,5 x 42,5</td><td>46x43</td><td>HS1816C</td></tr> <tr><td><input type="checkbox"/> 45,5 x 45</td><td>46x45</td><td>HS1817C</td></tr> <tr><td><input type="checkbox"/> 45,5 x 47,5</td><td>46x48</td><td>HS1818C</td></tr> <tr><td><input type="checkbox"/> 45,5 x 52,5</td><td>46x53</td><td>HS1820C</td></tr> <tr><td><input type="checkbox"/> 51 x 42,5</td><td>51x43</td><td>HS2016C</td></tr> <tr><td><input type="checkbox"/> 51 x 45</td><td>51x45</td><td>HS2017C</td></tr> <tr><td><input type="checkbox"/> 51 x 47,5</td><td>51x48</td><td>HS2018C</td></tr> <tr><td><input type="checkbox"/> 51 x 52,5</td><td>51x53</td><td>HS2020C</td></tr> </tbody> </table>	Misure cuscino LxP	Adatto a seduta LSxPS	Codice	<input type="checkbox"/> 43 x 45	43x45	HS1717C	<input type="checkbox"/> 43 x 47,5	43x48	HS1718C	<input type="checkbox"/> 43 x 52,5	43x53	HS1720C	<input type="checkbox"/> 45,5 x 42,5	46x43	HS1816C	<input type="checkbox"/> 45,5 x 45	46x45	HS1817C	<input type="checkbox"/> 45,5 x 47,5	46x48	HS1818C	<input type="checkbox"/> 45,5 x 52,5	46x53	HS1820C	<input type="checkbox"/> 51 x 42,5	51x43	HS2016C	<input type="checkbox"/> 51 x 45	51x45	HS2017C	<input type="checkbox"/> 51 x 47,5	51x48	HS2018C	<input type="checkbox"/> 51 x 52,5	51x53	HS2020C		
Misure cuscino LxP	Adatto a seduta LSxPS	Codice																																																																									
<input type="checkbox"/> 35,5 x 37,5	36x38	HS1414C																																																																									
<input type="checkbox"/> 35,5 x 42,5	36x43	HS1416C																																																																									
<input type="checkbox"/> 38 x 40	38x40	HS1515C																																																																									
<input type="checkbox"/> 38 x 42,5	38x43	HS1516C																																																																									
<input type="checkbox"/> 38 x 45	38x45	HS1517C																																																																									
<input type="checkbox"/> 40,5 x 40	41x40	HS1615C																																																																									
<input type="checkbox"/> 40,5 x 42,5	41x43	HS1616C																																																																									
<input type="checkbox"/> 40,5 x 45	41x45	HS1617C																																																																									
<input type="checkbox"/> 40,5 x 47,5	41x48	HS1618C																																																																									
<input type="checkbox"/> 40,5 x 52,5	41x53	HS1620C																																																																									
<input type="checkbox"/> 43 x 42,5	43x43	HS1716C																																																																									
Misure cuscino LxP	Adatto a seduta LSxPS	Codice																																																																									
<input type="checkbox"/> 43 x 45	43x45	HS1717C																																																																									
<input type="checkbox"/> 43 x 47,5	43x48	HS1718C																																																																									
<input type="checkbox"/> 43 x 52,5	43x53	HS1720C																																																																									
<input type="checkbox"/> 45,5 x 42,5	46x43	HS1816C																																																																									
<input type="checkbox"/> 45,5 x 45	46x45	HS1817C																																																																									
<input type="checkbox"/> 45,5 x 47,5	46x48	HS1818C																																																																									
<input type="checkbox"/> 45,5 x 52,5	46x53	HS1820C																																																																									
<input type="checkbox"/> 51 x 42,5	51x43	HS2016C																																																																									
<input type="checkbox"/> 51 x 45	51x45	HS2017C																																																																									
<input type="checkbox"/> 51 x 47,5	51x48	HS2018C																																																																									
<input type="checkbox"/> 51 x 52,5	51x53	HS2020C																																																																									
<b>ROHO® MONOCOMPARTIMENT® High Profile® altezza 10 cm</b> <span style="float: right;"><b>370,00</b></span>																																																																											
<table border="1"> <thead> <tr> <th>Misure cuscino LxP</th> <th>Adatto a seduta LSxPS</th> <th>Codice</th> </tr> </thead> <tbody> <tr><td><input type="checkbox"/> 30 x 30 - (6 x 6)</td><td>26,5+31 x 26,5+31</td><td>1R66C</td></tr> <tr><td><input type="checkbox"/> 30 x 33 - (6 x 7)</td><td>26,5+31 x 31+35</td><td>1R67C</td></tr> <tr><td><input type="checkbox"/> 33 x 33 - (7 x 7)</td><td>31+35 x 31+35</td><td>1R77C</td></tr> <tr><td><input type="checkbox"/> 33 x 38 - (7 x 8)</td><td>31+35 x 35+39,5</td><td>1R78C</td></tr> <tr><td><input type="checkbox"/> 33 x 42 - (7 x 9)</td><td>31+35 x 39,5+44</td><td>1R79C</td></tr> <tr><td><input type="checkbox"/> 38 x 33 - (8 x 7)</td><td>35+39,5 x 31+35</td><td>1R87C</td></tr> <tr><td><input type="checkbox"/> 38 x 38 - (8 x 8)</td><td>35+39,5 x 35+39,5</td><td>1R88C</td></tr> <tr><td><input type="checkbox"/> 38 x 42 - (8 x 9)</td><td>35+39,5 x 39,5+44</td><td>1R89C</td></tr> <tr><td><input type="checkbox"/> 38 x 46 - (8 x 10)</td><td>35+39,5 x 44+48,5</td><td>1R810C</td></tr> <tr><td><input type="checkbox"/> 42 x 38 - (9 x 8)</td><td>39,5+44 x 35+39,5</td><td>1R98C</td></tr> <tr><td><input type="checkbox"/> 42 x 42 - (9 x 9)</td><td>39,5+44 x 39,5+44</td><td>1R99C</td></tr> </tbody> </table>	Misure cuscino LxP	Adatto a seduta LSxPS	Codice	<input type="checkbox"/> 30 x 30 - (6 x 6)	26,5+31 x 26,5+31	1R66C	<input type="checkbox"/> 30 x 33 - (6 x 7)	26,5+31 x 31+35	1R67C	<input type="checkbox"/> 33 x 33 - (7 x 7)	31+35 x 31+35	1R77C	<input type="checkbox"/> 33 x 38 - (7 x 8)	31+35 x 35+39,5	1R78C	<input type="checkbox"/> 33 x 42 - (7 x 9)	31+35 x 39,5+44	1R79C	<input type="checkbox"/> 38 x 33 - (8 x 7)	35+39,5 x 31+35	1R87C	<input type="checkbox"/> 38 x 38 - (8 x 8)	35+39,5 x 35+39,5	1R88C	<input type="checkbox"/> 38 x 42 - (8 x 9)	35+39,5 x 39,5+44	1R89C	<input type="checkbox"/> 38 x 46 - (8 x 10)	35+39,5 x 44+48,5	1R810C	<input type="checkbox"/> 42 x 38 - (9 x 8)	39,5+44 x 35+39,5	1R98C	<input type="checkbox"/> 42 x 42 - (9 x 9)	39,5+44 x 39,5+44	1R99C	<table border="1"> <thead> <tr> <th>Misure cuscino LxP</th> <th>Adatto a seduta LSxPS</th> <th>Codice</th> </tr> </thead> <tbody> <tr><td><input type="checkbox"/> 42 x 46 - (9 x 10)</td><td>39,5+44 x 44+48,5</td><td>1R910C</td></tr> <tr><td><input type="checkbox"/> 42 x 51 - (9 x 11)</td><td>39,5+44 x 48,5+52,5</td><td>1R911C</td></tr> <tr><td><input type="checkbox"/> 46 x 38 - (10 x 8)</td><td>44+48,5 x 35+39,5</td><td>1R108C</td></tr> <tr><td><input type="checkbox"/> 46 x 42 - (10 x 9)</td><td>44+48,5 x 39,5+44</td><td>1R109C</td></tr> <tr><td><input type="checkbox"/> 46 x 46 - (10 x 10)</td><td>44+48,5 x 44+48,5</td><td>1R1010C</td></tr> <tr><td><input type="checkbox"/> 46 x 51 - (10 x 11)</td><td>44+48,5 x 48,5+52,5</td><td>1R1011C</td></tr> <tr><td><input type="checkbox"/> 46 x 56 - (10 x 12)</td><td>44+48,5 x 52,5+57</td><td>1R1012C</td></tr> <tr><td><input type="checkbox"/> 51 x 42 - (11 x 9)</td><td>48,5+52,5 x 39,5+44</td><td>1R119C</td></tr> <tr><td><input type="checkbox"/> 51 x 46 - (11 x 10)</td><td>48,5+52,5 x 44+48,5</td><td>1R1110C</td></tr> <tr><td><input type="checkbox"/> 51 x 51 - (11 x 11)</td><td>48,5+52,5 x 48,5+52,5</td><td>1R1111C</td></tr> <tr><td><input type="checkbox"/> 51 x 56 - (11 x 12)</td><td>48,5+52,5 x 52,5+57</td><td>1R1112C</td></tr> </tbody> </table>	Misure cuscino LxP	Adatto a seduta LSxPS	Codice	<input type="checkbox"/> 42 x 46 - (9 x 10)	39,5+44 x 44+48,5	1R910C	<input type="checkbox"/> 42 x 51 - (9 x 11)	39,5+44 x 48,5+52,5	1R911C	<input type="checkbox"/> 46 x 38 - (10 x 8)	44+48,5 x 35+39,5	1R108C	<input type="checkbox"/> 46 x 42 - (10 x 9)	44+48,5 x 39,5+44	1R109C	<input type="checkbox"/> 46 x 46 - (10 x 10)	44+48,5 x 44+48,5	1R1010C	<input type="checkbox"/> 46 x 51 - (10 x 11)	44+48,5 x 48,5+52,5	1R1011C	<input type="checkbox"/> 46 x 56 - (10 x 12)	44+48,5 x 52,5+57	1R1012C	<input type="checkbox"/> 51 x 42 - (11 x 9)	48,5+52,5 x 39,5+44	1R119C	<input type="checkbox"/> 51 x 46 - (11 x 10)	48,5+52,5 x 44+48,5	1R1110C	<input type="checkbox"/> 51 x 51 - (11 x 11)	48,5+52,5 x 48,5+52,5	1R1111C	<input type="checkbox"/> 51 x 56 - (11 x 12)	48,5+52,5 x 52,5+57	1R1112C		
Misure cuscino LxP	Adatto a seduta LSxPS	Codice																																																																									
<input type="checkbox"/> 30 x 30 - (6 x 6)	26,5+31 x 26,5+31	1R66C																																																																									
<input type="checkbox"/> 30 x 33 - (6 x 7)	26,5+31 x 31+35	1R67C																																																																									
<input type="checkbox"/> 33 x 33 - (7 x 7)	31+35 x 31+35	1R77C																																																																									
<input type="checkbox"/> 33 x 38 - (7 x 8)	31+35 x 35+39,5	1R78C																																																																									
<input type="checkbox"/> 33 x 42 - (7 x 9)	31+35 x 39,5+44	1R79C																																																																									
<input type="checkbox"/> 38 x 33 - (8 x 7)	35+39,5 x 31+35	1R87C																																																																									
<input type="checkbox"/> 38 x 38 - (8 x 8)	35+39,5 x 35+39,5	1R88C																																																																									
<input type="checkbox"/> 38 x 42 - (8 x 9)	35+39,5 x 39,5+44	1R89C																																																																									
<input type="checkbox"/> 38 x 46 - (8 x 10)	35+39,5 x 44+48,5	1R810C																																																																									
<input type="checkbox"/> 42 x 38 - (9 x 8)	39,5+44 x 35+39,5	1R98C																																																																									
<input type="checkbox"/> 42 x 42 - (9 x 9)	39,5+44 x 39,5+44	1R99C																																																																									
Misure cuscino LxP	Adatto a seduta LSxPS	Codice																																																																									
<input type="checkbox"/> 42 x 46 - (9 x 10)	39,5+44 x 44+48,5	1R910C																																																																									
<input type="checkbox"/> 42 x 51 - (9 x 11)	39,5+44 x 48,5+52,5	1R911C																																																																									
<input type="checkbox"/> 46 x 38 - (10 x 8)	44+48,5 x 35+39,5	1R108C																																																																									
<input type="checkbox"/> 46 x 42 - (10 x 9)	44+48,5 x 39,5+44	1R109C																																																																									
<input type="checkbox"/> 46 x 46 - (10 x 10)	44+48,5 x 44+48,5	1R1010C																																																																									
<input type="checkbox"/> 46 x 51 - (10 x 11)	44+48,5 x 48,5+52,5	1R1011C																																																																									
<input type="checkbox"/> 46 x 56 - (10 x 12)	44+48,5 x 52,5+57	1R1012C																																																																									
<input type="checkbox"/> 51 x 42 - (11 x 9)	48,5+52,5 x 39,5+44	1R119C																																																																									
<input type="checkbox"/> 51 x 46 - (11 x 10)	48,5+52,5 x 44+48,5	1R1110C																																																																									
<input type="checkbox"/> 51 x 51 - (11 x 11)	48,5+52,5 x 48,5+52,5	1R1111C																																																																									
<input type="checkbox"/> 51 x 56 - (11 x 12)	48,5+52,5 x 52,5+57	1R1112C																																																																									

Permobili Progeo Active Design s.r.l. - a Socio Unico - Vicolo L. Negrelli, 5 - 31038 Paese (TV) - Tel. +39 0422 484657  
 P. IVA, Codice Fiscale e Numero di iscrizione al Registro Imprese di Treviso 10246110968 - Fatturazione Elettronica: Codice Destinatario A4707H7 - Capitale Sociale I.V. € 10.000,00

Email: info\_fi@permobili.com - web: http://www.rehateamprogeo.com

Data \_\_\_\_\_ Commessa \_\_\_\_\_ Utilizzatore \_\_\_\_\_ Indirizzo \_\_\_\_\_

**O ROHO® MONOCOMPARTIMENT® Low Profile® altezza 5 cm** **370,00**

Misure cuscino LxP	Adatto a seduta LSxPS	Codice	Misure cuscino LxP	Adatto a seduta LSxPS	Codice
<input type="checkbox"/> 30 x 30 - (6 x 6)	26,5+31 x 26,5+31	<b>1R66LPC</b>	<input type="checkbox"/> 42 x 42 - (9 x 9)	39,5+44 x 39,5+44	<b>1R99LPC</b>
<input type="checkbox"/> 30 x 33 - (6 x 7)	26,5+31 x 31+35	<b>1R67LPC</b>	<input type="checkbox"/> 42 x 46 - (9 x 10)	39,5+44 x 44+48,5	<b>1R910LPC</b>
<input type="checkbox"/> 33 x 33 - (7 x 7)	31+35 x 31+35	<b>1R77LPC</b>	<input type="checkbox"/> 42 x 51 - (9 x 11)	39,5+44 x 48,5+52,5	<b>1R911LPC</b>
<input type="checkbox"/> 33 x 38 - (7 x 8)	31+35 x 35+39,5	<b>1R78LPC</b>	<input type="checkbox"/> 46 x 38 - (10 x 8)	44+48,5 x 35+39,5	<b>1R108LPC</b>
<input type="checkbox"/> 33 x 42 - (7 x 9)	31+35 x 39,5+44	<b>1R79LPC</b>	<input type="checkbox"/> 46 x 42 - (10 x 9)	44+48,5 x 39,5+44	<b>1R109LPC</b>
<input type="checkbox"/> 38 x 33 - (8 x 7)	35+39,5 x 31+35	<b>1R87LPC</b>	<input type="checkbox"/> 46 x 46 - (10 x 10)	44+48,5 x 44+48,5	<b>1R1010LPC</b>
<input type="checkbox"/> 38 x 38 - (8 x 8)	35+39,5 x 35+39,5	<b>1R88LPC</b>	<input type="checkbox"/> 46 x 51 - (10 x 11)	44+48,5 x 48,5+52,5	<b>1R1011LPC</b>
<input type="checkbox"/> 38 x 42 - (8 x 9)	35+39,5 x 39,5+44	<b>1R89LPC</b>	<input type="checkbox"/> 51 x 42 - (11 x 9)	48,5+52,5 x 39,5+44	<b>1R119LPC</b>
<input type="checkbox"/> 38 x 46 - (8 x 10)	35+39,5 x 44+48,5	<b>1R810LPC</b>	<input type="checkbox"/> 51 x 46 - (11 x 10)	48,5+52,5 x 44+48,5	<b>1R1110LPC</b>
<input type="checkbox"/> 42 x 38 - (9 x 8)	39,5+44 x 35+39,5	<b>1R98LPC</b>	<input type="checkbox"/> 51 x 51 - (11 x 11)	48,5+52,5 x 48,5+52,5	<b>1R1111LPC</b>



**O ROHO® QUADTRO SELECT® High Profile® altezza 10 cm** **630,00**

Misure cuscino LxP	Adatto a seduta LSxPS	Codice	Misure cuscino LxP	Adatto a seduta LSxPS	Codice
<input type="checkbox"/> 30 x 30 - (6 x 6)	26,5+31 x 26,5+31	<b>QS66C</b>	<input type="checkbox"/> 42 x 46 - (9 x 10)	39,5+44 x 44+48,5	<b>QS910C</b>
<input type="checkbox"/> 30 x 33 - (6 x 7)	26,5+31 x 31+35	<b>QS67C</b>	<input type="checkbox"/> 42 x 51 - (9 x 11)	39,5+44 x 48,5+52,5	<b>QS911C</b>
<input type="checkbox"/> 33 x 33 - (7 x 7)	31+35 x 31+35	<b>QS77C</b>	<input type="checkbox"/> 42 x 56 - (9 x 12)	39,5+44 x 52,5+57	<b>QS912C</b>
<input type="checkbox"/> 33 x 38 - (7 x 8)	31+35 x 35+39,5	<b>QS78C</b>	<input type="checkbox"/> 46 x 38 - (10 x 8)	44+48,5 x 35+39,5	<b>QS108C</b>
<input type="checkbox"/> 33 x 42 - (7 x 9)	31+35 x 39,5+44	<b>QS79C</b>	<input type="checkbox"/> 46 x 42 - (10 x 9)	44+48,5 x 39,5+44	<b>QS109C</b>
<input type="checkbox"/> 38 x 33 - (8 x 7)	35+39,5 x 31+35	<b>QS87C</b>	<input type="checkbox"/> 46 x 46 - (10 x 10)	44+48,5 x 44+48,5	<b>QS1010C</b>
<input type="checkbox"/> 38 x 38 - (8 x 8)	35+39,5 x 35+39,5	<b>QS88C</b>	<input type="checkbox"/> 46 x 51 - (10 x 11)	44+48,5 x 48,5+52,5	<b>QS1011C</b>
<input type="checkbox"/> 38 x 42 - (8 x 9)	35+39,5 x 39,5+44	<b>QS89C</b>	<input type="checkbox"/> 46 x 56 - (10 x 12)	44+48,5 x 52,5+57	<b>QS1012C</b>
<input type="checkbox"/> 38 x 46 - (8 x 10)	35+39,5 x 44+48,5	<b>QS810C</b>	<input type="checkbox"/> 51 x 42 - (11 x 9)	48,5+52,5 x 39,5+44	<b>QS119C</b>
<input type="checkbox"/> 42 x 38 - (9 x 8)	39,5+44 x 35+39,5	<b>QS98C</b>	<input type="checkbox"/> 51 x 46 - (11 x 10)	48,5+52,5 x 44+48,5	<b>QS1110C</b>
<input type="checkbox"/> 42 x 42 - (9 x 9)	39,5+44 x 39,5+44	<b>QS99C</b>	<input type="checkbox"/> 51 x 51 - (11 x 11)	48,5+52,5 x 48,5+52,5	<b>QS1111C</b>



**O ROHO® QUADTRO SELECT® Low Profile® altezza 5 cm** **630,00**

Misure cuscino LxP	Adatto a seduta LSxPS	Codice	Misure cuscino LxP	Adatto a seduta LSxPS	Codice
<input type="checkbox"/> 28 x 30 - (5 x 6)	22+26,5 x 26,5+31	<b>QS56LPC</b>	<input type="checkbox"/> 42 x 42 - (9 x 9)	39,5+44 x 39,5+44	<b>QS99LPC</b>
<input type="checkbox"/> 30 x 30 - (6 x 6)	26,5+31 x 26,5+31	<b>QS66LPC</b>	<input type="checkbox"/> 42 x 46 - (9 x 10)	39,5+44 x 44+48,5	<b>QS910LPC</b>
<input type="checkbox"/> 30 x 33 - (6 x 7)	26,5+31 x 31+35	<b>QS67LPC</b>	<input type="checkbox"/> 42 x 51 - (9 x 11)	39,5+44 x 48,5+52,5	<b>QS911LPC</b>
<input type="checkbox"/> 33 x 33 - (7 x 7)	31+35 x 31+35	<b>QS77LPC</b>	<input type="checkbox"/> 46 x 38 - (10 x 8)	44+48,5 x 35+39,5	<b>QS108LPC</b>
<input type="checkbox"/> 33 x 38 - (7 x 8)	31+35 x 35+39,5	<b>QS78LPC</b>	<input type="checkbox"/> 46 x 42 - (10 x 9)	44+48,5 x 39,5+44	<b>QS109LPC</b>
<input type="checkbox"/> 33 x 42 - (7 x 9)	31+35 x 39,5+44	<b>QS79LPC</b>	<input type="checkbox"/> 46 x 46 - (10 x 10)	44+48,5 x 44+48,5	<b>QS1010LPC</b>
<input type="checkbox"/> 38 x 33 - (8 x 7)	35+39,5 x 31+35	<b>QS87LPC</b>	<input type="checkbox"/> 46 x 51 - (10 x 11)	44+48,5 x 48,5+52,5	<b>QS1011LPC</b>
<input type="checkbox"/> 38 x 38 - (8 x 8)	35+39,5 x 35+39,5	<b>QS88LPC</b>	<input type="checkbox"/> 51 x 42 - (11 x 9)	48,5+52,5 x 39,5+44	<b>QS119LPC</b>
<input type="checkbox"/> 38 x 42 - (8 x 9)	35+39,5 x 39,5+44	<b>QS89LPC</b>	<input type="checkbox"/> 51 x 46 - (11 x 10)	48,5+52,5 x 44+48,5	<b>QS1110LPC</b>
<input type="checkbox"/> 38 x 46 - (8 x 10)	35+39,5 x 44+48,5	<b>QS810LPC</b>	<input type="checkbox"/> 51 x 51 - (11 x 11)	48,5+52,5 x 48,5+52,5	<b>QS1111LPC</b>
<input type="checkbox"/> 42 x 38 - (9 x 8)	39,5+44 x 35+39,5	<b>QS98LPC</b>			

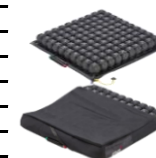

**O ROHO® CONTOUR SELECT®** **630,00**

Misure cuscino LxP	Adatto a seduta LSxPS	Codice	Misure cuscino LxP	Adatto a seduta LSxPS	Codice
<input type="checkbox"/> 33 x 38 - (7 x 8)	31+35 x 35+39,5	<b>CS78C</b>	<input type="checkbox"/> 42 x 51 - (9 x 11)	39,5+44 x 48,5+52,5	<b>CS911C</b>
<input type="checkbox"/> 38 x 38 - (8 x 8)	35+39,5 x 35+39,5	<b>CS88C</b>	<input type="checkbox"/> 46 x 42 - (10 x 9)	44+48,5 x 39,5+44	<b>CS109C</b>
<input type="checkbox"/> 38 x 42 - (8 x 9)	35+39,5 x 39,5+44	<b>CS89C</b>	<input type="checkbox"/> 46 x 46 - (10 x 10)	44+48,5 x 44+48,5	<b>CS1010C</b>
<input type="checkbox"/> 38 x 46 - (8 x 10)	35+39,5 x 44+48,5	<b>CS810C</b>	<input type="checkbox"/> 46 x 51 - (10 x 11)	44+48,5 x 48,5+52,5	<b>CS1011C</b>
<input type="checkbox"/> 42 x 38 - (9 x 8)	39,5+44 x 35+39,5	<b>CS98C</b>	<input type="checkbox"/> 51 x 42 - (11 x 9)	48,5+52,5 x 39,5+44	<b>CS119C</b>
<input type="checkbox"/> 42 x 42 - (9 x 9)	39,5+44 x 39,5+44	<b>CS99C</b>	<input type="checkbox"/> 51 x 46 - (11 x 10)	48,5+52,5 x 44+48,5	<b>CS1110C</b>
<input type="checkbox"/> 42 x 46 - (9 x 10)	39,5+44 x 44+48,5	<b>CS910C</b>	<input type="checkbox"/> 51 x 51 - (11 x 11)	48,5+52,5 x 48,5+52,5	<b>CS1111C</b>



**O ROHO® ENHANCER®** **630,00**

Misure cuscino LxP	Adatto a seduta LSxPS	Codice	Misure cuscino LxP	Adatto a seduta LSxPS	Codice
<input type="checkbox"/> 38 x 38 - (8 x 8)	35+39,5 x 35+39,5	<b>ENH88C</b>	<input type="checkbox"/> 46 x 42 - (10 x 9)	44+48,5 x 39,5+44	<b>ENH109C</b>
<input type="checkbox"/> 38 x 42 - (8 x 9)	35+39,5 x 39,5+44	<b>ENH89C</b>	<input type="checkbox"/> 46 x 46 - (10 x 10)	44+48,5 x 44+48,5	<b>ENH1010C</b>
<input type="checkbox"/> 42 x 38 - (9 x 8)	39,5+44 x 35+39,5	<b>ENH98C</b>	<input type="checkbox"/> 46 x 51 - (10 x 11)	44+48,5 x 48,5+52,5	<b>ENH1011C</b>
<input type="checkbox"/> 42 x 42 - (9 x 9)	39,5+44 x 39,5+44	<b>ENH99C</b>	<input type="checkbox"/> 51 x 46 - (11 x 10)	48,5+52,5 x 44+48,5	<b>ENH1110C</b>
<input type="checkbox"/> 42 x 46 - (9 x 10)	39,5+44 x 44+48,5	<b>ENH910C</b>			



Carrozzina : Progeo BASIC LIGHT - Rev. 2026.0

Prezzo IVA esclusa  
da sommare al prezzo di listino

Pagina da inviare se sono stati scelti optional

**standard** (fornito in assenza di altre indicazioni)

**su richiesta** (senza aggiunta di prezzo)

**optional** (sommare il prezzo a quello di listino)

Stampato il

Permobil Progeo Active Design s.r.l. - a Socio Unico - Vicolo L. Negrelli, 5 - 31038 Paese (TV) - Tel. +39 0422 484657  
 P.IVA, Codice Fiscale e Numero di iscrizione al Registro Imprese di Treviso 10246110968 - Fatturatore Elettronico: Codice Destinatario A4707H7 - Capitale Sociale I.V. € 10.000,00

Email: info\_fi@permobil.com - web: http://www.rehateamprogeo.com

Data ..... Commessa ..... Utilizzatore ..... Indirizzo .....

Ruota 12" - Motore 250W (potenza massima 750W)  
 Ruota 14" - Motore 1000W (potenza massima 1500W)

- Display a colori con pulsantiera
- Limite di velocità massima impostabile da display
- 5 livelli di velocità selezionabili
- 10 livelli di accelerazione selezionabili da display
- Cruise control adattivo (mantiene velocità anche in discesa)
- Leva di comando freno a disco ed elettronico
- Freno motore (regolabile in 10 livelli da display)
- Freno elettronico a pulsante (regolabile in 10 livelli da display)
- Recupero energia in frenata
- Gestione messaggi di errore da display (con registro storico)
- Segnalatore acustico retromarcia
- Batteria 48V - 5,8Ah Autonomia fino a 25km
- Batteria potenziata 48V - 11,6Ah Autonomia fino a 50km
- Caricabatteria 48V
- Retromarcia
- Ingresso USB
- Cavalletto di stazionamento
- Parafango ruota
- Cupolino anteriore con predisposizione faro FULL LED

**(Software certificato)**

**○ Mototronic**

Codici di riconducibilità Nomenclatore Tariffario  
 Riconducibile N.T. Cod. 12.21.27.006 - Carrozina elettrica ad uso interno/esterno  
 oppure  
 Riconducibile N.T. Cod. 12.24.09.015 - Kit di motorizzazione universale per carrozzine

10979 **2.900,00**



**Manubrio**

☆ **Comandi STANDARD**

☆ Acceleratore a pollice

☆ Destra  
12592

□ Sinistra  
12593

○ Acceleratore a manopola

○ Destra  
10913

○ Sinistra  
10914

**40,00**

□ Leva di comando freno a disco ed elettronico

☆ Destra  
12594

□ Sinistra  
12595

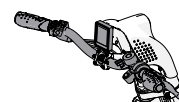

**○ Comandi per TETRAPLEGICI**

Manubrio PUSH&PULL



10905 **490,00**

☆ **MOTOTRONIK Ruota 12"**

Motore 250W (potenza massima 750W)  
 Velocità massima secondo norma di legge

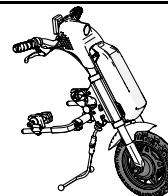

**○ MOTOTRONIK Ruota 14"**

Motore 1000W (potenza massima 1500W)  
 Velocità massima secondo norma di legge

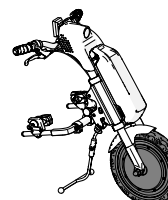

10903 **440,00**

**Batteria**

☆ Batteria 48V - 5,8Ah

*Autonomia fino a 25 km*

○ Batteria potenziata 48V - 11,6Ah

*Autonomia fino a 50 km*





10904 **330,00**

Permobili Progeo Active Design s.r.l. - a Socio Unico - Vicoletto L. Negrelli, 5 - 31038 Paese (TV) - Tel. +39 0422 484657  
 Numero di iscrizione al Registro Imprese di Treviso 10246110969 - Fatturazione Elettronica: Codice Destinatario A4707H7 - Capitale Sociale I.V. € 10.000,00  
 P. IVA, Codice Fiscale e Numero di iscrizione al Registro Imprese di Treviso 10246110969 - Fatturazione Elettronica: Codice Destinatario A4707H7 - Capitale Sociale I.V. € 10.000,00

Email: info\_it@permobil.com - web: http://www.rehateamprogeo.com

Data ..... Commessa ..... Utilizzatore ..... Indirizzo .....

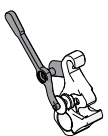
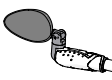
## Accessori

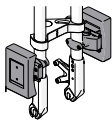
<input type="checkbox"/> Faro FULL LED (alta intensità) Incorporato sul cupolino		10908	
<input type="radio"/> Prolunga manubrio (avvicinamento guida) Regolabile da 15cm fino a 23cm		10907	190,00
<input type="radio"/> Leva sgancio facilitato gruppo motore Consigliato con manubrio per tetraplegici		10915	80,00
<input type="radio"/> FLY Batteria aggiuntiva 48V - 2,9Ah Autonomia fino a 15km Omologata per trasporto aereo		10906	600,00
<input type="radio"/> Specchietto retrovisore		10909	40,00
	<input type="radio"/> Destro <input type="radio"/> Sinistro	10909	40,00
<input type="radio"/> Cestino (removibile) - (con sistema di aggancio KCLICKfix®)		10912	200,00
<input type="radio"/> Zavorra anteriore removibile - (con sistema di aggancio KCLICKfix®) (Aumenta il peso della ruota motrice per migliorare la trazione)		10910	300,00
<input type="radio"/> Sacca da trasporto		10916	150,00

## Note

### Pagina da inviare se sono stati scelti optional

<input checked="" type="checkbox"/> standard	(fornito in assenza di altre indicazioni)
<input type="checkbox"/> su richiesta	(senza aggiunta di prezzo)
<input type="radio"/> optional	(sommare il prezzo a quello di listino)



Carrozzina : Progeo BASIC LIGHT - Rev. 2026.0

Prezzo IVA esclusa  
da sommare al prezzo di listino

Data ..... Commessa ..... Utilizzatore ..... Indirizzo .....

## SMARTDRIVE - compreso di caricabatteria



 <b>SWITCH CONTROL (DX+SX) - EU</b> Funzionamento a due pulsanti	<input type="radio"/> 6 KM/H	MX2-S002	4.000,00
	<input type="radio"/> 9 KM/H	MX2-S005	4.100,00
 <b>SWITCH CONTROL + JACK 3.5 - EU</b> Un pulsante e un ingresso femmina Mono che permette di collegare SmartDrive con un qualsiasi altro dispositivo di comando/guida.	<input type="radio"/> 6 KM/H	MX2-S003	4.000,00
	<input type="radio"/> 9 KM/H	MX2-S006	4.100,00

**Pulsante di comando esterno BUDDY BUTTON**  
 completo di adattatore, set di montaggio e braccio di estensione  
*Disponibile solo con SWITCH CONTROL + JACK 3.5*



MX2-BBB 250,00

### KIT FISSAGGIO TELAIO PIEGHEVOLE

Scegliere kit di fissaggio in funzione della misura delle ruote posteriori della carrozzina

- kit fissaggio telaio pieghevole - ruote posteriori 22" - 24" MX2-443-C
- kit fissaggio telaio pieghevole - ruote posteriori 25" MX2-453-C
- kit fissaggio telaio pieghevole - ruote posteriori 26" MX2-463-C

## SMART WATCH

Lo SmartDrive può essere comandato e gestito con uno Smart Watch APPLE o GALAXY  
 Configurazione semplice e veloce  
 Maggiore visibilità dello schermo  
 Prestazioni della batteria migliorate  
 App gratuita su Apple Store e Play Store

### Lista compatibilità'



### Smart Watch compatibili

**APPLE WATCH**  
 serie 5 o successivi con iOS 8 o successivi  
 Apple iPhone

**GALAXY WATCH**  
 serie 4 o successivi  
 Smartphone Samsung  
 Smartphone Android 6.0 e RAM almeno 1.5 GB

### Applicazioni gratuite

SmartDrive MX2+



Pushtracker



## Accessori

Borsa da trasporto



MX2SD-BAG 60,00

Maniglia universale imbottita  
*Maniglia universale imbottita*



MX2-986 20,00

Carrozzina : Progeo BASIC LIGHT - Rev. 2026.0

Prezzo IVA esclusa  
 da sommare al prezzo di listino

### Pagina da inviare se sono stati scelti optional

- standard** (fornito in assenza di altre indicazioni)
- su richiesta** (senza aggiunta di prezzo)
- optional** (sommare il prezzo a quello di listino)