

Italia

Data .....

Utilizzatore .....

Peso utilizzatore (kg) .....

Lingua manuale d'uso .....

Responsabile .....

Timbro ditta

Carrozzina pieghevole basculante

### Informazioni sull'utilizzatore

Patologia utilizzatore: .....

Presenza di spasmi importanti o distonie:  SI  NO      Peso utilizzatore (kg):.....Kg

Misure carrozzina - La tolleranza su tutte le dimensioni indicate e/o richieste è di  $\pm 10$  mm

### Larghezza sedile (LS)

#### MODELLO ADULTO

33    36    39    42    45    48

Kit allargamento seduta (LS + 3cm)      09876      **90,00**  
 Non montato       Montato

#### MODELLO BAMBINO

27    30    33    36    39

Kit allargamento seduta (LS + 3cm)      11476      **90,00**  
 Non montato       Montato

### Profondità sedile (PS) - regolabile!

#### Telaio corto

35    37,5    40

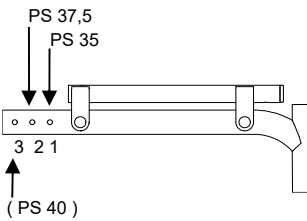

#### Telaio medio

40    42,5    45

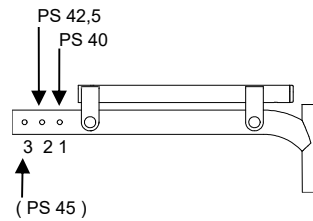

#### Telaio lungo

45    47,5    50

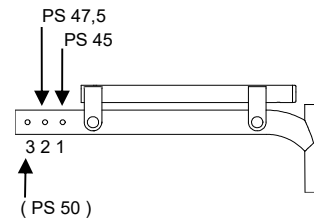

Posizione tubo schienale

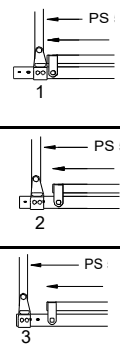

### Distanza pedana (DP) - (Distanza tela sedile - piatto pedana)

ATTENZIONE! Altezza anteriore minimo 4 cm maggiore della DISTANZA PEDANA

Distanza pedana minima possibile ~22cm

.....(cm)  $\pm 0,5$ cm - step di regolazione 1,5cm

### Altezza carrozzina (con seduta parallela al terreno)

	Ruote posteriori				Ruote posteriori				
	12"	16"	22"	24"	12"	16"	22"	24"	
<b>RUOTE ANTERIORI 6"</b>	<input type="checkbox"/> 42 <input type="checkbox"/> 43,3 <input type="checkbox"/> 44,5 <input type="checkbox"/> 45,8 <input type="checkbox"/> 47	<input type="checkbox"/> 47 <input type="checkbox"/> 48,3	<input type="checkbox"/> 42 <input type="checkbox"/> 43,3 <input type="checkbox"/> 44,5 <input type="checkbox"/> 45,8	<input type="checkbox"/> 43,3 <input type="checkbox"/> 44,5 <input type="checkbox"/> 45,8 <input type="checkbox"/> 47 <input type="checkbox"/> 48,3	<b>RUOTE ANTERIORI 7"</b>	<input type="checkbox"/> 44,5 <input type="checkbox"/> 45,8 <input type="checkbox"/> 47	<input type="checkbox"/> 47 <input type="checkbox"/> 48,3	<input type="checkbox"/> 44,5 <input type="checkbox"/> 45,8	<input type="checkbox"/> 44,5 <input type="checkbox"/> 45,8 <input type="checkbox"/> 47 <input type="checkbox"/> 48,3

### Telaio anteriore

☆ Telaio dritto  
(non disponibile per larghezza 27)

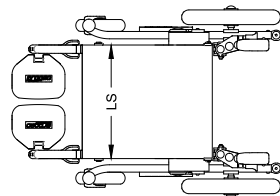

Telaio con abduzione 6cm  
non disponibile per larghezza 42 - 45 - 48  
Distanza pedana massima possibile 42

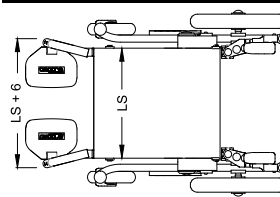

Telaio anteriore elevabile, girevole ed estraibile  
non disponibile per larghezza 27 - 30 - 33  
Distanza pedana minima possibile 25cm.

### Telaio anteriore girevole ed estraibile

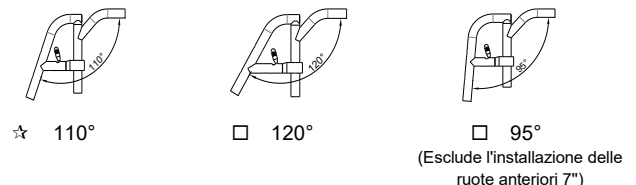

### Telaio anteriore girevole ed estraibile

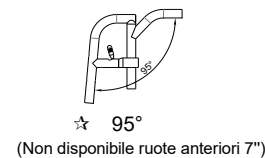

Completo supporti polpaccio e di appoggiapiedi in plastica con fascia ferma talloni



09730      **250,00**

Permobili Progeo Active Design s.r.l. - a Socio Unico - Vicolo L. Negrilli, 5 - 31038 Paese (TV) - Tel. +39 0422 484657  
P.IVA, Codice Fiscale e Numero di iscrizione al Registro Imprese di Treviso 10246110968 - Fatturazione Elettronica: Codice Destinatario A4707H7 - Capitale Sociale I.V. € 10.000,00

Email: info\_@permobili.com - web: http://www.rehateamprogeo.com

Data ..... Commessa ..... Utilizzatore ..... Indirizzo .....

**Colore telaio**

- ☆ Nero opaco
- Bianco POLAR
- Grigio opaco
- Rosso opaco
- Arancio Opaco
- Blu notte opaco
- Verde Neon
- Grigio Mercurio

**Maniglione unico di spinta per accompagnatore**

Maniglione di spinta con comando basculamento - REMOVIBILE

angolo regolabile

Con schienale fisso (non abbattibile) regolabile in altezza 30÷70cm (Rispetto alla seduta)

Con schienale abbattibile regolabile in altezza 20÷60cm (Rispetto alla seduta)

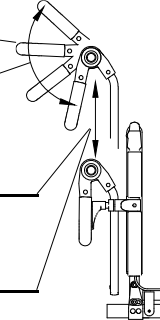

**Schienale**

☆ Schienale fisso (non abbattibile) angolo regolabile da -4° a +12°

Schienale abbattibile angolo regolabile da -4° a +12° 09728 270,00

Schienale reclinabile (Non abbattibile) inclinazione dinamica con molla a gas 10090 310,00

La profondità seduta effettiva misurata da inizio tela sedile a tubo schienale risulta maggiorata di 1,5 cm

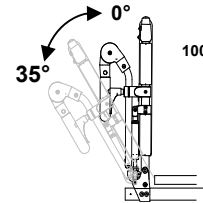

**Imbottitura schienale**

☆ SENZA schienale tensionabile imbottito traspirante.

**Altezza schienale (TS) ..... (std 42cm)**

CON schienale tensionabile imbottito traspirante. Completo di patella di raccordo schienale/tela sedile. 04693 120,00

Con schienale fisso (non abbattibile)->altezza minima possibile 39cm

**Altezza schienale (TS) ..... (std 42cm)**

**Ruote anteriori**

- ☆ 6" Piena Soft
- 6" Pneumatica
- 7" Piena Soft

**Non disponibile con: Telaio anteriore 95°**

**Ruote posteriori**

☆ Ruote da transito da 12" - Copertura piena

- Ruote da transito da 12" - Pneumatica
- Ruote da transito da 16" - Pneumatica
- 24" Superleggera Standard Progeo 04696 120,00
- 22" Superleggera Standard Progeo 04696 120,00
- 24" Superleggera "Spinergy LX" 04691 800,00
- 24" Superleggera "Spinergy LXL" 07848 800,00
- 24" Superleggera "Spinergy Flex rim" 02270 1.200,00
- 24" Fuoristrada (corrimano in alluminio nero - Distanza ruota 4cm) 04690 300,00
- 12" con freno a tamburo per accompagnatore  Copertura piena  Pneumatica 04105 320,00
- 16" con freno a tamburo per accompagnatore - Pneumatica 04107 320,00
- 24" con freno a tamburo per accompagnatore (corrimano in alluminio - Distanza ruota 3cm) 03384 350,00

**Colore ruote posteriori**

Solo le ruote standard Progeo 22"/24" hanno mozzi e cerchi colorati

- ☆ Nero 22" 24" 00833 130,00
- Bianco POLAR 22" 24" 00833 130,00
- Grigio opaco 22" 24" 00833 130,00
- Blu notte opaco 22" 24" 00833 130,00
- Rosso opaco 22" 24" 00833 130,00
- Verde Neon 22" 24" 00833 130,00
- Grigio Mercurio 22" 24" 00833 130,00
- Magenta Pop 22" 24" 00833 130,00

**Cerchi di spinta**

Distanza ruota ☆ 3 cm  4 cm

- ☆ Alluminio (22-24")
- Alluminio Nero SOFT-TOUCH (24") 09170 110,00
- Acciaio cromato (24") 01684 170,00
- Titanio (24") 00016 270,00
- Ultra Grepp (24") 00017 300,00
- TOP FRICTION (24") 11023 290,00
- Profilo ovale con inserto in gomma**
- NOVA H (24") 11025 270,00
- Profilo ergonomico colore nero**
- NOVA D (24") 11026 290,00
- Profilo ergonomico con rivestimento in gomma (ideale per tetraplegici)**
- Anello anti scivolo in silicone applicabile su cerchio in alluminio 04050 170,00

P.IVA, Codice Fiscale e Numero di iscrizione al Registro Imprese di Treviso 10246110968 - Fatturazione Elettronica: Codice Destinatario A4707HT - Capitale Sociale I.V. € 10.000,00  
 Permobili Progeo Active Design s.r.l. - a Socio Unico - Vicolo L. Negrelli, 5 - 31038 Paese (TV) - Tel. +39 0422 484657  
 Email: info\_it@permobil.com - web: http://www.rehateamprogeo.com

Data ..... Commessa ..... Utilizzatore ..... Indirizzo .....

### Copertura ruota posteriore

- Liscio Alta Pressione (22-24")
  - Tassellato Alta Pressione (24")
  - Marathon Plus (24") con protezione anti foratura 01669 **90,00**
  - Copertura piena - Colore Grigio (22") 04181 **110,00**
  - Copertura piena - Colore Nero (24") 11083 **110,00**
- Non disponibile con Ruote posteriori: 24" Superleggere "Spinergy LXL"**

### Freni

- Freno leva curva da spingere 
- Freno leva dritta da spingere 
- Freno leva dritta da tirare 
- Freno con leva prolungata da spingere 01949 **70,00**
- Freno con leva prolungata da tirare 03372 **70,00**

### Pedana (Non disponibile con Telaio anteriore elevabile, girevole ed estraibile)

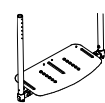
- Pedana sdoppiata in plastica, regolabile in inclinazione  11525  
 Distanza pedana minima possibile ~22cm  
 Non disponibile con: Telaio anteriore con pedana elevabile, girevole ed estraibile
- Pedana unica alzabile in alluminio regolabile in profondità e inclinazione  09727 **130,00**  
 Non disponibile per larghezza 27-30 con telaio anteriore dritto  
 Distanza pedana minima possibile ~21cm  
 Non disponibile con: Telaio anteriore con pedana elevabile, girevole ed estraibile  
 interna  2/3 interna  2/3 esterna  esterna

### Braccioli estraibili CON protezione vestiario integrata

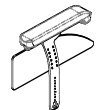
- Braccioli Desk PROGEO (Estraibili regolabili in altezza) 
- Braccioli estraibili con protezione dritta in ABS (Estraibili regolabili in altezza)  
 Distanza tela sedile - imbottitura bracciolo (cm)  21  23  25  27  29 



### SAFETY

- Sistema di ancoraggio a 4 punti per fissaggio carrozzina  
 (l'installazione deve essere eseguita dalla casa costruttrice)  
 Installare un appoggiatesta idoneo per il trasporto e posizionarlo sempre adeguatamente durante il trasporto.  08654 **190,00**

### Accessori

- Imbottitura paracolpi telaio anteriore 07058 **50,00**
- Borsello portaoggetti removibile (con aggancio rapido) 09811 **120,00**

### Optional 1

- Ruota antiribaltamento con aggancio rapido (rotazione all'interno per ridurre l'ingombro)  
 FORNITE DI SERIE 
- Poggiatesta Super Head Multiadattabile (sistema pieghevole con la carrozzina)  11477 **360,00**
- Ruote ascensore  00836 **170,00**
- Aiuto ribaltamento  Destro 00025 **90,00**  
 Sinistro 01046 **90,00**
- Porta stampelle  Destro 00838 **80,00**  
 Sinistro 00837 **80,00**

### Optional 2

- Cinghia di bretellaggio 04103 **130,00**
- Cinghia pelvica di ancoraggio 03972 **70,00**
- Tavolino (estraibile) 00508 **260,00**
- Supporto lombare (da inserire all'interno dello schienale) 00013 **50,00**
- Copriraggi Nero (22-24") 01043 **160,00**
- Copriraggi Trasparente (22-24") 00835 **160,00**
- Copriraggi Colorato Progeo Design (22-24") 00019 **180,00**

Permobili Progeo Active Design s.r.l. - a Socio Unico - Vicolo L. Negrilli, 5 - 31038 Paese (TV) - Tel. +39 0422 484657 -  
 P.IVA, Codice Fiscale e Numero di iscrizione al Registro Imprese di Treviso 10246110968 - Fatturazione Elettronica: Codice Destinatario A4707H7 - Capitale Sociale I.V. € 10.000,00

Email: info\_it@permobil.com - web: http://www.rehateamprogeo.com

Data ..... Commessa ..... Utilizzatore ..... Indirizzo .....

Supporto lombare STIMULITE



00064 220,00





**PHYSIO - Imbottitura schienale originale non fornita**

Estraibile con aggancio rapido  
Installazione su tubi diametro 18÷26mm  
Regolazione in profondità (4cm)  
Regolazione inclinazione (±18°)

**Schienale posturale VERSIONE KID BAMBINO**

**KID** Guscio ALLUMINIO







ATTENZIONE con questo schienale si riduce la profondità della seduta di circa 5cm.

ALTEZZA SCHIENALE	29	34	40	830,00
Conformazione del guscio	Ala di contenimento laterale R=regolare			
	R	R	R	
				

**Schienale posturale VERSIONE ADULTO**

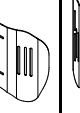

**AIR** Guscio CARBONIO

non disponibile per larghezza 27 - 30

ALTEZZA SCHIENALE	28	34	40	860,00		
Conformazione del guscio	Ala di contenimento laterale A=alta - R=regolare					
	A	R	A		R	
						

**POSTURE** Guscio ALLUMINIO

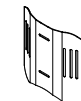
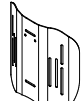
non disponibile per larghezza 27 - 30

ALTEZZA SCHIENALE	34	40	52	830,00
Conformazione del guscio	Ala di contenimento laterale R=regolare			
	R	R	R	
				

**Configurazione DEEP con PAD per contenimento laterale (regolabili in altezza)**

Pad in alluminio con imbottitura e rivestimento in tessuto traspirante



Piccolo (h 13cm)



Destro 10272 40,00

Sinistro 10272 40,00

Grande (h 20cm)



Destro 10273 50,00

Sinistro 10273 50,00

Per mobili Progeo Active Design s.r.l. - a Socio Unico - Via S. L. Negrelli, 5 - 31038 Paese (TV) - Tel. +39 0422 484657  
P.IVA, Codice Fiscale e Numero di iscrizione al Registro Imprese di Treviso 10246110968 - Fatturazione Elettronica: Codice Destinatario A4707HT7 - Capitale Sociale I.V. € 10.000,00

Email: info\_it@permobili.com - web: http://www.rehateamprogeo.com

Data ..... Commessa ..... Utilizzatore ..... Indirizzo .....

**Accessori**





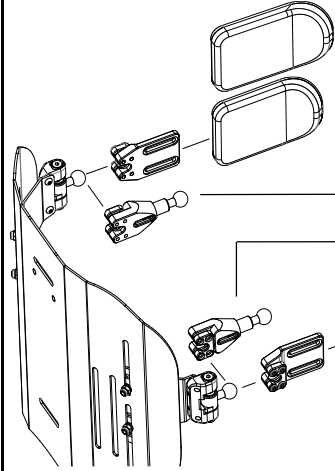

*KID AIR POSTURE*

○ Supporti toracici (spinta laterale) - SWING AWAY - Girevole  
Non disponibile su schienale Physio AIR Guscio in Carbonio  
Hardware di fissaggio e regolazione completi di imbottitura paracolpi  
Pad in alluminio con imbottitura e rivestimento in tessuto traspirante

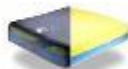

<input type="radio"/> Grande (18x12)	05647	170,00
<input type="radio"/> Piccola (14x9)	05643	170,00
<input type="radio"/> Prolunga supporto toracico	Quantità (n° pz).....	10271 60,00
<input type="radio"/> Prolunga supporto toracico	Quantità (n° pz).....	
<input type="radio"/> Piccola (14x9)	05642	170,00
<input type="radio"/> Grande (18x12)	05646	170,00
<input type="radio"/> Poggiatesta multiregolazione - sistema di montaggio a doppia sfera Disponibile solo su schienale Physio Posture e Kid	<input type="checkbox"/> Grande (35x12,5) <input type="checkbox"/> Piccola (25x12,5)	05648 360,00

**Cuscini antidecubito e posturali a nido d'ape STIMULITE**

○ Classic H 7 cm.	<input type="checkbox"/> 36x41 00035	<input type="checkbox"/> 38x38 00036	<input type="checkbox"/> 38x41 01052	<input type="checkbox"/> 41x41 00037		630,00
	<input type="checkbox"/> 41x46 00840	<input type="checkbox"/> 46x41 00698	<input type="checkbox"/> 46x46 00038			
○ Anatomico Posturale H 9 cm. H 5cm. nella zona ischiatica	<input type="checkbox"/> 36x41 00056	<input type="checkbox"/> 38x38 00696	<input type="checkbox"/> 38x41 00032	<input type="checkbox"/> 41x41 00033		630,00
	<input type="checkbox"/> 41x46 01050	<input type="checkbox"/> 46x41 00034	<input type="checkbox"/> 46x46 01051			
○ Slimline sagomato H 7 cm. H 5cm. nella zona ischiatica	<input type="checkbox"/> 36x41 00854	<input type="checkbox"/> 38x38 00707	<input type="checkbox"/> 38x41 00083	<input type="checkbox"/> 41x41 01073		630,00
	<input type="checkbox"/> 41x46 00085	<input type="checkbox"/> 46x41 01074	<input type="checkbox"/> 46x46 01075			
○ Sport H 5 cm.	<input type="checkbox"/> 36x41 00053	<input type="checkbox"/> 38x38 00054	<input type="checkbox"/> 38x41 01060	<input type="checkbox"/> 41x41 01061		630,00
	<input type="checkbox"/> 41x46 00057	<input type="checkbox"/> 46x41 01062	<input type="checkbox"/> 46x46 00846			
○ Silver H 3,5 cm.	<input type="checkbox"/> 41x41 00641	<input type="checkbox"/> 41x46 01353	<input type="checkbox"/> 46x41 00642	<input type="checkbox"/> 46x46 01022		630,00
○ Corbee Pediatrico H 5 cm.	<input type="checkbox"/> 25x25 00052	<input type="checkbox"/> 30x30 00845	<input type="checkbox"/> 36x36 00079			630,00
○ Pediatrico anatomico posturale H 6 cm. H 5cm. nella zona ischiatica	<input type="checkbox"/> 25x25 00638	<input type="checkbox"/> 30x30 01351	<input type="checkbox"/> 36x36 00639			630,00

Misura cliente Larghezza cm. .... Profondità cm. ....

**Ricambi consigliati**

Il ricambio corrisponderà a quanto previsto nella configurazione della carrozzina







○ <b>KIT ruote anteriori - Include la coppia di ruote e 4 viti di fissaggio</b>		
6" Piena Soft	14195	35,00
6" Pneumatica	14196	45,00
7" Piena Soft	14197	45,00
○ <b>Copertura ruota posteriore - Include la coppia di copertoni e camere d'aria</b>		
Liscio Alta Pressione	14183	45,00
Tassellato Alta Pressione	14184	45,00
Marathon Plus	14185	85,00
Copertura piena	14186	110,00

Carrozina : Progeo TEKNA TILT 2.0 - Rev. 2026.1

Prezzo IVA esclusa  
da sommare al prezzo di listino

**Pagina da inviare se sono stati scelti optional**

<input checked="" type="checkbox"/> standard	(fornito in assenza di altre indicazioni)
<input type="checkbox"/> su richiesta	(senza aggiunta di prezzo)
<input type="checkbox"/> optional	(sommare il prezzo a quello di listino)

Data	Commessa	Utilizzatore	Indirizzo																																																																								
<b>ROHO® MOSAIC® - H7cm - Limite di peso 143Kg</b> <span style="float: right;"><b>200,00</b></span>																																																																											
<table border="1"> <thead> <tr> <th>Misure cuscino LxP</th> <th>Adatto a seduta LSxPS</th> <th>Codice</th> </tr> </thead> <tbody> <tr><td><input type="checkbox"/> 41 x 41</td><td>42 x 42</td><td>MOS1616HD</td></tr> <tr><td><input type="checkbox"/> 41 x 46</td><td>42 x 47</td><td>MOS1618HD</td></tr> <tr><td><input type="checkbox"/> 44 x 44</td><td>44 x 44</td><td>MOS1717HD</td></tr> </tbody> </table>	Misure cuscino LxP	Adatto a seduta LSxPS	Codice	<input type="checkbox"/> 41 x 41	42 x 42	MOS1616HD	<input type="checkbox"/> 41 x 46	42 x 47	MOS1618HD	<input type="checkbox"/> 44 x 44	44 x 44	MOS1717HD	<table border="1"> <thead> <tr> <th>Misure cuscino LxP</th> <th>Adatto a seduta LSxPS</th> <th>Codice</th> </tr> </thead> <tbody> <tr><td><input type="checkbox"/> 46 x 41</td><td>47 x 42</td><td>MOS1816HD</td></tr> <tr><td><input type="checkbox"/> 46 x 46</td><td>47 x 47</td><td>MOS1818HD</td></tr> <tr><td><input type="checkbox"/> 51 x 46</td><td>52 x 47</td><td>MOS2018HD</td></tr> </tbody> </table>	Misure cuscino LxP	Adatto a seduta LSxPS	Codice	<input type="checkbox"/> 46 x 41	47 x 42	MOS1816HD	<input type="checkbox"/> 46 x 46	47 x 47	MOS1818HD	<input type="checkbox"/> 51 x 46	52 x 47	MOS2018HD																																																		
Misure cuscino LxP	Adatto a seduta LSxPS	Codice																																																																									
<input type="checkbox"/> 41 x 41	42 x 42	MOS1616HD																																																																									
<input type="checkbox"/> 41 x 46	42 x 47	MOS1618HD																																																																									
<input type="checkbox"/> 44 x 44	44 x 44	MOS1717HD																																																																									
Misure cuscino LxP	Adatto a seduta LSxPS	Codice																																																																									
<input type="checkbox"/> 46 x 41	47 x 42	MOS1816HD																																																																									
<input type="checkbox"/> 46 x 46	47 x 47	MOS1818HD																																																																									
<input type="checkbox"/> 51 x 46	52 x 47	MOS2018HD																																																																									
<b>ROHO® AIR LITE® - H9,5cm - Limite di peso 136Kg</b> <span style="float: right;"><b>200,00</b></span>																																																																											
<table border="1"> <thead> <tr> <th>Misure cuscino LxP</th> <th>Codice</th> </tr> </thead> <tbody> <tr><td><input type="checkbox"/> 33 x 33</td><td>AL1313HD</td></tr> <tr><td><input type="checkbox"/> 33 x 38</td><td>AL1315HD</td></tr> <tr><td><input type="checkbox"/> 36 x 36</td><td>AL1414HD</td></tr> <tr><td><input type="checkbox"/> 36 x 41</td><td>AL1416HD</td></tr> <tr><td><input type="checkbox"/> 38 x 38</td><td>AL1515HD</td></tr> <tr><td><input type="checkbox"/> 38 x 43</td><td>AL1517HD</td></tr> <tr><td><input type="checkbox"/> 41 x 41</td><td>AL1616HD</td></tr> <tr><td><input type="checkbox"/> 41 x 46</td><td>AL1618HD</td></tr> <tr><td><input type="checkbox"/> 43 x 43</td><td>AL1717HD</td></tr> </tbody> </table>	Misure cuscino LxP	Codice	<input type="checkbox"/> 33 x 33	AL1313HD	<input type="checkbox"/> 33 x 38	AL1315HD	<input type="checkbox"/> 36 x 36	AL1414HD	<input type="checkbox"/> 36 x 41	AL1416HD	<input type="checkbox"/> 38 x 38	AL1515HD	<input type="checkbox"/> 38 x 43	AL1517HD	<input type="checkbox"/> 41 x 41	AL1616HD	<input type="checkbox"/> 41 x 46	AL1618HD	<input type="checkbox"/> 43 x 43	AL1717HD	<table border="1"> <thead> <tr> <th>Misure cuscino LxP</th> <th>Codice</th> </tr> </thead> <tbody> <tr><td><input type="checkbox"/> 43 x 46</td><td>AL1718HD</td></tr> <tr><td><input type="checkbox"/> 43 x 51</td><td>AL1720HD</td></tr> <tr><td><input type="checkbox"/> 46 x 41</td><td>AL1816HD</td></tr> <tr><td><input type="checkbox"/> 46 x 46</td><td>AL1818HD</td></tr> <tr><td><input type="checkbox"/> 46 x 51</td><td>AL1820HD</td></tr> <tr><td><input type="checkbox"/> 48 x 43</td><td>AL1917HD</td></tr> <tr><td><input type="checkbox"/> 48 x 48</td><td>AL1919HD</td></tr> <tr><td><input type="checkbox"/> 51 x 43</td><td>AL2017HD</td></tr> <tr><td><input type="checkbox"/> 51 x 46</td><td>AL2018HD</td></tr> </tbody> </table>	Misure cuscino LxP	Codice	<input type="checkbox"/> 43 x 46	AL1718HD	<input type="checkbox"/> 43 x 51	AL1720HD	<input type="checkbox"/> 46 x 41	AL1816HD	<input type="checkbox"/> 46 x 46	AL1818HD	<input type="checkbox"/> 46 x 51	AL1820HD	<input type="checkbox"/> 48 x 43	AL1917HD	<input type="checkbox"/> 48 x 48	AL1919HD	<input type="checkbox"/> 51 x 43	AL2017HD	<input type="checkbox"/> 51 x 46	AL2018HD																																		
Misure cuscino LxP	Codice																																																																										
<input type="checkbox"/> 33 x 33	AL1313HD																																																																										
<input type="checkbox"/> 33 x 38	AL1315HD																																																																										
<input type="checkbox"/> 36 x 36	AL1414HD																																																																										
<input type="checkbox"/> 36 x 41	AL1416HD																																																																										
<input type="checkbox"/> 38 x 38	AL1515HD																																																																										
<input type="checkbox"/> 38 x 43	AL1517HD																																																																										
<input type="checkbox"/> 41 x 41	AL1616HD																																																																										
<input type="checkbox"/> 41 x 46	AL1618HD																																																																										
<input type="checkbox"/> 43 x 43	AL1717HD																																																																										
Misure cuscino LxP	Codice																																																																										
<input type="checkbox"/> 43 x 46	AL1718HD																																																																										
<input type="checkbox"/> 43 x 51	AL1720HD																																																																										
<input type="checkbox"/> 46 x 41	AL1816HD																																																																										
<input type="checkbox"/> 46 x 46	AL1818HD																																																																										
<input type="checkbox"/> 46 x 51	AL1820HD																																																																										
<input type="checkbox"/> 48 x 43	AL1917HD																																																																										
<input type="checkbox"/> 48 x 48	AL1919HD																																																																										
<input type="checkbox"/> 51 x 43	AL2017HD																																																																										
<input type="checkbox"/> 51 x 46	AL2018HD																																																																										
<b>ROHO® HYBRID ELITE SR® - Monovalvola - Sensor Ready - Limite di peso 225Kg</b> <span style="float: right;"><b>630,00</b></span>																																																																											
<table border="1"> <thead> <tr> <th>Misure cuscino LxP</th> <th>Adatto a seduta LSxPS</th> <th>Codice</th> </tr> </thead> <tbody> <tr><td><input type="checkbox"/> 35 x 37,5</td><td>36 x 36</td><td>1RHE1414C-SR</td></tr> <tr><td><input type="checkbox"/> 35 x 40</td><td>36 x 38</td><td>1RHE1415C-SR</td></tr> <tr><td><input type="checkbox"/> 35 x 43</td><td>36 x 41</td><td>1RHE1416C-SR</td></tr> <tr><td><input type="checkbox"/> 37,5 x 40</td><td>38 x 38</td><td>1RHE1515C-SR</td></tr> <tr><td><input type="checkbox"/> 37,5 x 43</td><td>38 x 41</td><td>1RHE1516C-SR</td></tr> <tr><td><input type="checkbox"/> 37,5 x 45</td><td>38 x 43</td><td>1RHE1517C-SR</td></tr> <tr><td><input type="checkbox"/> 40 x 40</td><td>41 x 38</td><td>1RHE1615C-SR</td></tr> <tr><td><input type="checkbox"/> 40 x 43</td><td>41 x 41</td><td>1RHE1616C-SR</td></tr> <tr><td><input type="checkbox"/> 40 x 45</td><td>41 x 43</td><td>1RHE1617C-SR</td></tr> <tr><td><input type="checkbox"/> 40 x 48</td><td>41 x 46</td><td>1RHE1618C-SR</td></tr> <tr><td><input type="checkbox"/> 40 x 53</td><td>41 x 51</td><td>1RHE1620C-SR</td></tr> </tbody> </table>	Misure cuscino LxP	Adatto a seduta LSxPS	Codice	<input type="checkbox"/> 35 x 37,5	36 x 36	1RHE1414C-SR	<input type="checkbox"/> 35 x 40	36 x 38	1RHE1415C-SR	<input type="checkbox"/> 35 x 43	36 x 41	1RHE1416C-SR	<input type="checkbox"/> 37,5 x 40	38 x 38	1RHE1515C-SR	<input type="checkbox"/> 37,5 x 43	38 x 41	1RHE1516C-SR	<input type="checkbox"/> 37,5 x 45	38 x 43	1RHE1517C-SR	<input type="checkbox"/> 40 x 40	41 x 38	1RHE1615C-SR	<input type="checkbox"/> 40 x 43	41 x 41	1RHE1616C-SR	<input type="checkbox"/> 40 x 45	41 x 43	1RHE1617C-SR	<input type="checkbox"/> 40 x 48	41 x 46	1RHE1618C-SR	<input type="checkbox"/> 40 x 53	41 x 51	1RHE1620C-SR	<table border="1"> <thead> <tr> <th>Misure cuscino LxP</th> <th>Adatto a seduta LSxPS</th> <th>Codice</th> </tr> </thead> <tbody> <tr><td><input type="checkbox"/> 43 x 43</td><td>43 x 41</td><td>1RHE1716C-SR</td></tr> <tr><td><input type="checkbox"/> 43 x 45</td><td>43 x 43</td><td>1RHE1717C-SR</td></tr> <tr><td><input type="checkbox"/> 43 x 48</td><td>43 x 46</td><td>1RHE1718C-SR</td></tr> <tr><td><input type="checkbox"/> 43 x 53</td><td>43 x 51</td><td>1RHE1720C-SR</td></tr> <tr><td><input type="checkbox"/> 45 x 43</td><td>46 x 41</td><td>1RHE1816C-SR</td></tr> <tr><td><input type="checkbox"/> 45 x 45</td><td>46 x 43</td><td>1RHE1817C-SR</td></tr> <tr><td><input type="checkbox"/> 45 x 48</td><td>46 x 46</td><td>1RHE1818C-SR</td></tr> <tr><td><input type="checkbox"/> 45 x 53</td><td>46 x 51</td><td>1RHE1820C-SR</td></tr> <tr><td><input type="checkbox"/> 50 x 45</td><td>51 x 43</td><td>1RHE2017C-SR</td></tr> <tr><td><input type="checkbox"/> 50 x 48</td><td>51 x 46</td><td>1RHE2018C-SR</td></tr> <tr><td><input type="checkbox"/> 50 x 53</td><td>51 x 51</td><td>1RHE2020C-SR</td></tr> </tbody> </table>	Misure cuscino LxP	Adatto a seduta LSxPS	Codice	<input type="checkbox"/> 43 x 43	43 x 41	1RHE1716C-SR	<input type="checkbox"/> 43 x 45	43 x 43	1RHE1717C-SR	<input type="checkbox"/> 43 x 48	43 x 46	1RHE1718C-SR	<input type="checkbox"/> 43 x 53	43 x 51	1RHE1720C-SR	<input type="checkbox"/> 45 x 43	46 x 41	1RHE1816C-SR	<input type="checkbox"/> 45 x 45	46 x 43	1RHE1817C-SR	<input type="checkbox"/> 45 x 48	46 x 46	1RHE1818C-SR	<input type="checkbox"/> 45 x 53	46 x 51	1RHE1820C-SR	<input type="checkbox"/> 50 x 45	51 x 43	1RHE2017C-SR	<input type="checkbox"/> 50 x 48	51 x 46	1RHE2018C-SR	<input type="checkbox"/> 50 x 53	51 x 51	1RHE2020C-SR		
Misure cuscino LxP	Adatto a seduta LSxPS	Codice																																																																									
<input type="checkbox"/> 35 x 37,5	36 x 36	1RHE1414C-SR																																																																									
<input type="checkbox"/> 35 x 40	36 x 38	1RHE1415C-SR																																																																									
<input type="checkbox"/> 35 x 43	36 x 41	1RHE1416C-SR																																																																									
<input type="checkbox"/> 37,5 x 40	38 x 38	1RHE1515C-SR																																																																									
<input type="checkbox"/> 37,5 x 43	38 x 41	1RHE1516C-SR																																																																									
<input type="checkbox"/> 37,5 x 45	38 x 43	1RHE1517C-SR																																																																									
<input type="checkbox"/> 40 x 40	41 x 38	1RHE1615C-SR																																																																									
<input type="checkbox"/> 40 x 43	41 x 41	1RHE1616C-SR																																																																									
<input type="checkbox"/> 40 x 45	41 x 43	1RHE1617C-SR																																																																									
<input type="checkbox"/> 40 x 48	41 x 46	1RHE1618C-SR																																																																									
<input type="checkbox"/> 40 x 53	41 x 51	1RHE1620C-SR																																																																									
Misure cuscino LxP	Adatto a seduta LSxPS	Codice																																																																									
<input type="checkbox"/> 43 x 43	43 x 41	1RHE1716C-SR																																																																									
<input type="checkbox"/> 43 x 45	43 x 43	1RHE1717C-SR																																																																									
<input type="checkbox"/> 43 x 48	43 x 46	1RHE1718C-SR																																																																									
<input type="checkbox"/> 43 x 53	43 x 51	1RHE1720C-SR																																																																									
<input type="checkbox"/> 45 x 43	46 x 41	1RHE1816C-SR																																																																									
<input type="checkbox"/> 45 x 45	46 x 43	1RHE1817C-SR																																																																									
<input type="checkbox"/> 45 x 48	46 x 46	1RHE1818C-SR																																																																									
<input type="checkbox"/> 45 x 53	46 x 51	1RHE1820C-SR																																																																									
<input type="checkbox"/> 50 x 45	51 x 43	1RHE2017C-SR																																																																									
<input type="checkbox"/> 50 x 48	51 x 46	1RHE2018C-SR																																																																									
<input type="checkbox"/> 50 x 53	51 x 51	1RHE2020C-SR																																																																									
<b>ROHO® HYBRID ELITE® - Bivalvola /Bicompartimento - Limite di peso 225Kg</b> <span style="float: right;"><b>630,00</b></span>																																																																											
<table border="1"> <thead> <tr> <th>Misure cuscino LxP</th> <th>Adatto a seduta LSxPS</th> <th>Codice</th> </tr> </thead> <tbody> <tr><td><input type="checkbox"/> 35 x 37,5</td><td>36 x 36</td><td>2RHE1414C</td></tr> <tr><td><input type="checkbox"/> 35 x 40</td><td>36 x 38</td><td>2RHE1415C</td></tr> <tr><td><input type="checkbox"/> 35 x 43</td><td>36 x 41</td><td>2RHE1416C</td></tr> <tr><td><input type="checkbox"/> 37,5 x 40</td><td>38 x 38</td><td>2RHE1515C</td></tr> <tr><td><input type="checkbox"/> 37,5 x 43</td><td>38 x 41</td><td>2RHE1516C</td></tr> <tr><td><input type="checkbox"/> 37,5 x 45</td><td>38 x 43</td><td>2RHE1517C</td></tr> <tr><td><input type="checkbox"/> 40 x 40</td><td>41 x 38</td><td>2RHE1615C</td></tr> <tr><td><input type="checkbox"/> 40 x 43</td><td>41 x 41</td><td>2RHE1616C</td></tr> <tr><td><input type="checkbox"/> 40 x 45</td><td>41 x 43</td><td>2RHE1617C</td></tr> <tr><td><input type="checkbox"/> 40 x 48</td><td>41 x 46</td><td>2RHE1618C</td></tr> <tr><td><input type="checkbox"/> 40 x 53</td><td>41 x 51</td><td>2RHE1620C</td></tr> </tbody> </table>	Misure cuscino LxP	Adatto a seduta LSxPS	Codice	<input type="checkbox"/> 35 x 37,5	36 x 36	2RHE1414C	<input type="checkbox"/> 35 x 40	36 x 38	2RHE1415C	<input type="checkbox"/> 35 x 43	36 x 41	2RHE1416C	<input type="checkbox"/> 37,5 x 40	38 x 38	2RHE1515C	<input type="checkbox"/> 37,5 x 43	38 x 41	2RHE1516C	<input type="checkbox"/> 37,5 x 45	38 x 43	2RHE1517C	<input type="checkbox"/> 40 x 40	41 x 38	2RHE1615C	<input type="checkbox"/> 40 x 43	41 x 41	2RHE1616C	<input type="checkbox"/> 40 x 45	41 x 43	2RHE1617C	<input type="checkbox"/> 40 x 48	41 x 46	2RHE1618C	<input type="checkbox"/> 40 x 53	41 x 51	2RHE1620C	<table border="1"> <thead> <tr> <th>Misure cuscino LxP</th> <th>Adatto a seduta LSxPS</th> <th>Codice</th> </tr> </thead> <tbody> <tr><td><input type="checkbox"/> 43 x 43</td><td>43 x 41</td><td>2RHE1716C</td></tr> <tr><td><input type="checkbox"/> 43 x 45</td><td>43 x 43</td><td>2RHE1717C</td></tr> <tr><td><input type="checkbox"/> 43 x 48</td><td>43 x 46</td><td>2RHE1718C</td></tr> <tr><td><input type="checkbox"/> 43 x 53</td><td>43 x 51</td><td>2RHE1720C</td></tr> <tr><td><input type="checkbox"/> 45 x 43</td><td>46 x 41</td><td>2RHE1816C</td></tr> <tr><td><input type="checkbox"/> 45 x 45</td><td>46 x 43</td><td>2RHE1817C</td></tr> <tr><td><input type="checkbox"/> 45 x 48</td><td>46 x 46</td><td>2RHE1818C</td></tr> <tr><td><input type="checkbox"/> 45 x 53</td><td>46 x 51</td><td>2RHE1820C</td></tr> <tr><td><input type="checkbox"/> 50 x 45</td><td>51 x 43</td><td>2RHE2017C</td></tr> <tr><td><input type="checkbox"/> 50 x 48</td><td>51 x 46</td><td>2RHE2018C</td></tr> <tr><td><input type="checkbox"/> 50 x 53</td><td>51 x 51</td><td>2RHE2020C</td></tr> </tbody> </table>	Misure cuscino LxP	Adatto a seduta LSxPS	Codice	<input type="checkbox"/> 43 x 43	43 x 41	2RHE1716C	<input type="checkbox"/> 43 x 45	43 x 43	2RHE1717C	<input type="checkbox"/> 43 x 48	43 x 46	2RHE1718C	<input type="checkbox"/> 43 x 53	43 x 51	2RHE1720C	<input type="checkbox"/> 45 x 43	46 x 41	2RHE1816C	<input type="checkbox"/> 45 x 45	46 x 43	2RHE1817C	<input type="checkbox"/> 45 x 48	46 x 46	2RHE1818C	<input type="checkbox"/> 45 x 53	46 x 51	2RHE1820C	<input type="checkbox"/> 50 x 45	51 x 43	2RHE2017C	<input type="checkbox"/> 50 x 48	51 x 46	2RHE2018C	<input type="checkbox"/> 50 x 53	51 x 51	2RHE2020C		
Misure cuscino LxP	Adatto a seduta LSxPS	Codice																																																																									
<input type="checkbox"/> 35 x 37,5	36 x 36	2RHE1414C																																																																									
<input type="checkbox"/> 35 x 40	36 x 38	2RHE1415C																																																																									
<input type="checkbox"/> 35 x 43	36 x 41	2RHE1416C																																																																									
<input type="checkbox"/> 37,5 x 40	38 x 38	2RHE1515C																																																																									
<input type="checkbox"/> 37,5 x 43	38 x 41	2RHE1516C																																																																									
<input type="checkbox"/> 37,5 x 45	38 x 43	2RHE1517C																																																																									
<input type="checkbox"/> 40 x 40	41 x 38	2RHE1615C																																																																									
<input type="checkbox"/> 40 x 43	41 x 41	2RHE1616C																																																																									
<input type="checkbox"/> 40 x 45	41 x 43	2RHE1617C																																																																									
<input type="checkbox"/> 40 x 48	41 x 46	2RHE1618C																																																																									
<input type="checkbox"/> 40 x 53	41 x 51	2RHE1620C																																																																									
Misure cuscino LxP	Adatto a seduta LSxPS	Codice																																																																									
<input type="checkbox"/> 43 x 43	43 x 41	2RHE1716C																																																																									
<input type="checkbox"/> 43 x 45	43 x 43	2RHE1717C																																																																									
<input type="checkbox"/> 43 x 48	43 x 46	2RHE1718C																																																																									
<input type="checkbox"/> 43 x 53	43 x 51	2RHE1720C																																																																									
<input type="checkbox"/> 45 x 43	46 x 41	2RHE1816C																																																																									
<input type="checkbox"/> 45 x 45	46 x 43	2RHE1817C																																																																									
<input type="checkbox"/> 45 x 48	46 x 46	2RHE1818C																																																																									
<input type="checkbox"/> 45 x 53	46 x 51	2RHE1820C																																																																									
<input type="checkbox"/> 50 x 45	51 x 43	2RHE2017C																																																																									
<input type="checkbox"/> 50 x 48	51 x 46	2RHE2018C																																																																									
<input type="checkbox"/> 50 x 53	51 x 51	2RHE2020C																																																																									
<b>ROHO® HYBRID SELECT®</b> <span style="float: right;"><b>630,00</b></span>																																																																											
<table border="1"> <thead> <tr> <th>Misure cuscino LxP</th> <th>Adatto a seduta LSxPS</th> <th>Codice</th> </tr> </thead> <tbody> <tr><td><input type="checkbox"/> 35,5 x 37,5</td><td>36x38</td><td>HS1414C</td></tr> <tr><td><input type="checkbox"/> 35,5 x 42,5</td><td>36x43</td><td>HS1416C</td></tr> <tr><td><input type="checkbox"/> 38 x 40</td><td>38x40</td><td>HS1515C</td></tr> <tr><td><input type="checkbox"/> 38 x 42,5</td><td>38x43</td><td>HS1516C</td></tr> <tr><td><input type="checkbox"/> 38 x 45</td><td>38x45</td><td>HS1517C</td></tr> <tr><td><input type="checkbox"/> 40,5 x 40</td><td>41x40</td><td>HS1615C</td></tr> <tr><td><input type="checkbox"/> 40,5 x 42,5</td><td>41x43</td><td>HS1616C</td></tr> <tr><td><input type="checkbox"/> 40,5 x 45</td><td>41x45</td><td>HS1617C</td></tr> <tr><td><input type="checkbox"/> 40,5 x 47,5</td><td>41x48</td><td>HS1618C</td></tr> <tr><td><input type="checkbox"/> 40,5 x 52,5</td><td>41x53</td><td>HS1620C</td></tr> <tr><td><input type="checkbox"/> 43 x 42,5</td><td>43x43</td><td>HS1716C</td></tr> </tbody> </table>	Misure cuscino LxP	Adatto a seduta LSxPS	Codice	<input type="checkbox"/> 35,5 x 37,5	36x38	HS1414C	<input type="checkbox"/> 35,5 x 42,5	36x43	HS1416C	<input type="checkbox"/> 38 x 40	38x40	HS1515C	<input type="checkbox"/> 38 x 42,5	38x43	HS1516C	<input type="checkbox"/> 38 x 45	38x45	HS1517C	<input type="checkbox"/> 40,5 x 40	41x40	HS1615C	<input type="checkbox"/> 40,5 x 42,5	41x43	HS1616C	<input type="checkbox"/> 40,5 x 45	41x45	HS1617C	<input type="checkbox"/> 40,5 x 47,5	41x48	HS1618C	<input type="checkbox"/> 40,5 x 52,5	41x53	HS1620C	<input type="checkbox"/> 43 x 42,5	43x43	HS1716C	<table border="1"> <thead> <tr> <th>Misure cuscino LxP</th> <th>Adatto a seduta LSxPS</th> <th>Codice</th> </tr> </thead> <tbody> <tr><td><input type="checkbox"/> 43 x 45</td><td>43x45</td><td>HS1717C</td></tr> <tr><td><input type="checkbox"/> 43 x 47,5</td><td>43x48</td><td>HS1718C</td></tr> <tr><td><input type="checkbox"/> 43 x 52,5</td><td>43x53</td><td>HS1720C</td></tr> <tr><td><input type="checkbox"/> 45,5 x 42,5</td><td>46x43</td><td>HS1816C</td></tr> <tr><td><input type="checkbox"/> 45,5 x 45</td><td>46x45</td><td>HS1817C</td></tr> <tr><td><input type="checkbox"/> 45,5 x 47,5</td><td>46x48</td><td>HS1818C</td></tr> <tr><td><input type="checkbox"/> 45,5 x 52,5</td><td>46x53</td><td>HS1820C</td></tr> <tr><td><input type="checkbox"/> 51 x 42,5</td><td>51x43</td><td>HS2016C</td></tr> <tr><td><input type="checkbox"/> 51 x 45</td><td>51x45</td><td>HS2017C</td></tr> <tr><td><input type="checkbox"/> 51 x 47,5</td><td>51x48</td><td>HS2018C</td></tr> <tr><td><input type="checkbox"/> 51 x 52,5</td><td>51x53</td><td>HS2020C</td></tr> </tbody> </table>	Misure cuscino LxP	Adatto a seduta LSxPS	Codice	<input type="checkbox"/> 43 x 45	43x45	HS1717C	<input type="checkbox"/> 43 x 47,5	43x48	HS1718C	<input type="checkbox"/> 43 x 52,5	43x53	HS1720C	<input type="checkbox"/> 45,5 x 42,5	46x43	HS1816C	<input type="checkbox"/> 45,5 x 45	46x45	HS1817C	<input type="checkbox"/> 45,5 x 47,5	46x48	HS1818C	<input type="checkbox"/> 45,5 x 52,5	46x53	HS1820C	<input type="checkbox"/> 51 x 42,5	51x43	HS2016C	<input type="checkbox"/> 51 x 45	51x45	HS2017C	<input type="checkbox"/> 51 x 47,5	51x48	HS2018C	<input type="checkbox"/> 51 x 52,5	51x53	HS2020C		
Misure cuscino LxP	Adatto a seduta LSxPS	Codice																																																																									
<input type="checkbox"/> 35,5 x 37,5	36x38	HS1414C																																																																									
<input type="checkbox"/> 35,5 x 42,5	36x43	HS1416C																																																																									
<input type="checkbox"/> 38 x 40	38x40	HS1515C																																																																									
<input type="checkbox"/> 38 x 42,5	38x43	HS1516C																																																																									
<input type="checkbox"/> 38 x 45	38x45	HS1517C																																																																									
<input type="checkbox"/> 40,5 x 40	41x40	HS1615C																																																																									
<input type="checkbox"/> 40,5 x 42,5	41x43	HS1616C																																																																									
<input type="checkbox"/> 40,5 x 45	41x45	HS1617C																																																																									
<input type="checkbox"/> 40,5 x 47,5	41x48	HS1618C																																																																									
<input type="checkbox"/> 40,5 x 52,5	41x53	HS1620C																																																																									
<input type="checkbox"/> 43 x 42,5	43x43	HS1716C																																																																									
Misure cuscino LxP	Adatto a seduta LSxPS	Codice																																																																									
<input type="checkbox"/> 43 x 45	43x45	HS1717C																																																																									
<input type="checkbox"/> 43 x 47,5	43x48	HS1718C																																																																									
<input type="checkbox"/> 43 x 52,5	43x53	HS1720C																																																																									
<input type="checkbox"/> 45,5 x 42,5	46x43	HS1816C																																																																									
<input type="checkbox"/> 45,5 x 45	46x45	HS1817C																																																																									
<input type="checkbox"/> 45,5 x 47,5	46x48	HS1818C																																																																									
<input type="checkbox"/> 45,5 x 52,5	46x53	HS1820C																																																																									
<input type="checkbox"/> 51 x 42,5	51x43	HS2016C																																																																									
<input type="checkbox"/> 51 x 45	51x45	HS2017C																																																																									
<input type="checkbox"/> 51 x 47,5	51x48	HS2018C																																																																									
<input type="checkbox"/> 51 x 52,5	51x53	HS2020C																																																																									
<b>ROHO® MONOCOMPARTIMENT® High Profile® altezza 10 cm</b> <span style="float: right;"><b>370,00</b></span>																																																																											
<table border="1"> <thead> <tr> <th>Misure cuscino LxP</th> <th>Adatto a seduta LSxPS</th> <th>Codice</th> </tr> </thead> <tbody> <tr><td><input type="checkbox"/> 30 x 30 - (6 x 6)</td><td>26,5+31 x 26,5+31</td><td>1R66C</td></tr> <tr><td><input type="checkbox"/> 30 x 33 - (6 x 7)</td><td>26,5+31 x 31+35</td><td>1R67C</td></tr> <tr><td><input type="checkbox"/> 33 x 33 - (7 x 7)</td><td>31+35 x 31+35</td><td>1R77C</td></tr> <tr><td><input type="checkbox"/> 33 x 38 - (7 x 8)</td><td>31+35 x 35+39,5</td><td>1R78C</td></tr> <tr><td><input type="checkbox"/> 33 x 42 - (7 x 9)</td><td>31+35 x 39,5+44</td><td>1R79C</td></tr> <tr><td><input type="checkbox"/> 38 x 33 - (8 x 7)</td><td>35+39,5 x 31+35</td><td>1R87C</td></tr> <tr><td><input type="checkbox"/> 38 x 38 - (8 x 8)</td><td>35+39,5 x 35+39,5</td><td>1R88C</td></tr> <tr><td><input type="checkbox"/> 38 x 42 - (8 x 9)</td><td>35+39,5 x 39,5+44</td><td>1R89C</td></tr> <tr><td><input type="checkbox"/> 38 x 46 - (8 x 10)</td><td>35+39,5 x 44+48,5</td><td>1R810C</td></tr> <tr><td><input type="checkbox"/> 42 x 38 - (9 x 8)</td><td>39,5+44 x 35+39,5</td><td>1R98C</td></tr> <tr><td><input type="checkbox"/> 42 x 42 - (9 x 9)</td><td>39,5+44 x 39,5+44</td><td>1R99C</td></tr> </tbody> </table>	Misure cuscino LxP	Adatto a seduta LSxPS	Codice	<input type="checkbox"/> 30 x 30 - (6 x 6)	26,5+31 x 26,5+31	1R66C	<input type="checkbox"/> 30 x 33 - (6 x 7)	26,5+31 x 31+35	1R67C	<input type="checkbox"/> 33 x 33 - (7 x 7)	31+35 x 31+35	1R77C	<input type="checkbox"/> 33 x 38 - (7 x 8)	31+35 x 35+39,5	1R78C	<input type="checkbox"/> 33 x 42 - (7 x 9)	31+35 x 39,5+44	1R79C	<input type="checkbox"/> 38 x 33 - (8 x 7)	35+39,5 x 31+35	1R87C	<input type="checkbox"/> 38 x 38 - (8 x 8)	35+39,5 x 35+39,5	1R88C	<input type="checkbox"/> 38 x 42 - (8 x 9)	35+39,5 x 39,5+44	1R89C	<input type="checkbox"/> 38 x 46 - (8 x 10)	35+39,5 x 44+48,5	1R810C	<input type="checkbox"/> 42 x 38 - (9 x 8)	39,5+44 x 35+39,5	1R98C	<input type="checkbox"/> 42 x 42 - (9 x 9)	39,5+44 x 39,5+44	1R99C	<table border="1"> <thead> <tr> <th>Misure cuscino LxP</th> <th>Adatto a seduta LSxPS</th> <th>Codice</th> </tr> </thead> <tbody> <tr><td><input type="checkbox"/> 42 x 46 - (9 x 10)</td><td>39,5+44 x 44+48,5</td><td>1R910C</td></tr> <tr><td><input type="checkbox"/> 42 x 51 - (9 x 11)</td><td>39,5+44 x 48,5+52,5</td><td>1R911C</td></tr> <tr><td><input type="checkbox"/> 46 x 38 - (10 x 8)</td><td>44+48,5 x 35+39,5</td><td>1R108C</td></tr> <tr><td><input type="checkbox"/> 46 x 42 - (10 x 9)</td><td>44+48,5 x 39,5+44</td><td>1R109C</td></tr> <tr><td><input type="checkbox"/> 46 x 46 - (10 x 10)</td><td>44+48,5 x 44+48,5</td><td>1R1010C</td></tr> <tr><td><input type="checkbox"/> 46 x 51 - (10 x 11)</td><td>44+48,5 x 48,5+52,5</td><td>1R1011C</td></tr> <tr><td><input type="checkbox"/> 46 x 56 - (10 x 12)</td><td>44+48,5 x 52,5+57</td><td>1R1012C</td></tr> <tr><td><input type="checkbox"/> 51 x 42 - (11 x 9)</td><td>48,5+52,5 x 39,5+44</td><td>1R119C</td></tr> <tr><td><input type="checkbox"/> 51 x 46 - (11 x 10)</td><td>48,5+52,5 x 44+48,5</td><td>1R1110C</td></tr> <tr><td><input type="checkbox"/> 51 x 51 - (11 x 11)</td><td>48,5+52,5 x 48,5+52,5</td><td>1R1111C</td></tr> <tr><td><input type="checkbox"/> 51 x 56 - (11 x 12)</td><td>48,5+52,5 x 52,5+57</td><td>1R1112C</td></tr> </tbody> </table>	Misure cuscino LxP	Adatto a seduta LSxPS	Codice	<input type="checkbox"/> 42 x 46 - (9 x 10)	39,5+44 x 44+48,5	1R910C	<input type="checkbox"/> 42 x 51 - (9 x 11)	39,5+44 x 48,5+52,5	1R911C	<input type="checkbox"/> 46 x 38 - (10 x 8)	44+48,5 x 35+39,5	1R108C	<input type="checkbox"/> 46 x 42 - (10 x 9)	44+48,5 x 39,5+44	1R109C	<input type="checkbox"/> 46 x 46 - (10 x 10)	44+48,5 x 44+48,5	1R1010C	<input type="checkbox"/> 46 x 51 - (10 x 11)	44+48,5 x 48,5+52,5	1R1011C	<input type="checkbox"/> 46 x 56 - (10 x 12)	44+48,5 x 52,5+57	1R1012C	<input type="checkbox"/> 51 x 42 - (11 x 9)	48,5+52,5 x 39,5+44	1R119C	<input type="checkbox"/> 51 x 46 - (11 x 10)	48,5+52,5 x 44+48,5	1R1110C	<input type="checkbox"/> 51 x 51 - (11 x 11)	48,5+52,5 x 48,5+52,5	1R1111C	<input type="checkbox"/> 51 x 56 - (11 x 12)	48,5+52,5 x 52,5+57	1R1112C		
Misure cuscino LxP	Adatto a seduta LSxPS	Codice																																																																									
<input type="checkbox"/> 30 x 30 - (6 x 6)	26,5+31 x 26,5+31	1R66C																																																																									
<input type="checkbox"/> 30 x 33 - (6 x 7)	26,5+31 x 31+35	1R67C																																																																									
<input type="checkbox"/> 33 x 33 - (7 x 7)	31+35 x 31+35	1R77C																																																																									
<input type="checkbox"/> 33 x 38 - (7 x 8)	31+35 x 35+39,5	1R78C																																																																									
<input type="checkbox"/> 33 x 42 - (7 x 9)	31+35 x 39,5+44	1R79C																																																																									
<input type="checkbox"/> 38 x 33 - (8 x 7)	35+39,5 x 31+35	1R87C																																																																									
<input type="checkbox"/> 38 x 38 - (8 x 8)	35+39,5 x 35+39,5	1R88C																																																																									
<input type="checkbox"/> 38 x 42 - (8 x 9)	35+39,5 x 39,5+44	1R89C																																																																									
<input type="checkbox"/> 38 x 46 - (8 x 10)	35+39,5 x 44+48,5	1R810C																																																																									
<input type="checkbox"/> 42 x 38 - (9 x 8)	39,5+44 x 35+39,5	1R98C																																																																									
<input type="checkbox"/> 42 x 42 - (9 x 9)	39,5+44 x 39,5+44	1R99C																																																																									
Misure cuscino LxP	Adatto a seduta LSxPS	Codice																																																																									
<input type="checkbox"/> 42 x 46 - (9 x 10)	39,5+44 x 44+48,5	1R910C																																																																									
<input type="checkbox"/> 42 x 51 - (9 x 11)	39,5+44 x 48,5+52,5	1R911C																																																																									
<input type="checkbox"/> 46 x 38 - (10 x 8)	44+48,5 x 35+39,5	1R108C																																																																									
<input type="checkbox"/> 46 x 42 - (10 x 9)	44+48,5 x 39,5+44	1R109C																																																																									
<input type="checkbox"/> 46 x 46 - (10 x 10)	44+48,5 x 44+48,5	1R1010C																																																																									
<input type="checkbox"/> 46 x 51 - (10 x 11)	44+48,5 x 48,5+52,5	1R1011C																																																																									
<input type="checkbox"/> 46 x 56 - (10 x 12)	44+48,5 x 52,5+57	1R1012C																																																																									
<input type="checkbox"/> 51 x 42 - (11 x 9)	48,5+52,5 x 39,5+44	1R119C																																																																									
<input type="checkbox"/> 51 x 46 - (11 x 10)	48,5+52,5 x 44+48,5	1R1110C																																																																									
<input type="checkbox"/> 51 x 51 - (11 x 11)	48,5+52,5 x 48,5+52,5	1R1111C																																																																									
<input type="checkbox"/> 51 x 56 - (11 x 12)	48,5+52,5 x 52,5+57	1R1112C																																																																									

Permobili Progeo Active Design s.r.l. - a Socio Unico - Vicolo L. Negrelli, 5 - 31038 Paese (TV) - Tel. +39 0422 484657  
 P. IVA, Codice Fiscale e Numero di iscrizione al Registro Imprese di Treviso 10246110968 - Fatturazione Elettronica: Codice Destinatario A4707H7 - Capitale Sociale I.V. € 10.000,00

Email: info\_fi@permobili.com - web: http://www.rehateamprogeo.com

Data ..... Compressa ..... Utilizzatore ..... Indirizzo .....

**ROHO® MONOCOMPARTIMENT® Low Profile® altezza 5 cm** **370,00**

Misure cuscino LxP	Adatto a seduta LSxPS	Codice	Misure cuscino LxP	Adatto a seduta LSxPS	Codice
<input type="checkbox"/> 30 x 30 - (6 x 6)	26,5+31 x 26,5+31	<b>1R66LPC</b>	<input type="checkbox"/> 42 x 42 - (9 x 9)	39,5+44 x 39,5+44	<b>1R99LPC</b>
<input type="checkbox"/> 30 x 33 - (6 x 7)	26,5+31 x 31+35	<b>1R67LPC</b>	<input type="checkbox"/> 42 x 46 - (9 x 10)	39,5+44 x 44+48,5	<b>1R910LPC</b>
<input type="checkbox"/> 33 x 33 - (7 x 7)	31+35 x 31+35	<b>1R77LPC</b>	<input type="checkbox"/> 42 x 51 - (9 x 11)	39,5+44 x 48,5+52,5	<b>1R911LPC</b>
<input type="checkbox"/> 33 x 38 - (7 x 8)	31+35 x 35+39,5	<b>1R78LPC</b>	<input type="checkbox"/> 46 x 38 - (10 x 8)	44+48,5 x 35+39,5	<b>1R108LPC</b>
<input type="checkbox"/> 33 x 42 - (7 x 9)	31+35 x 39,5+44	<b>1R79LPC</b>	<input type="checkbox"/> 46 x 42 - (10 x 9)	44+48,5 x 39,5+44	<b>1R109LPC</b>
<input type="checkbox"/> 38 x 33 - (8 x 7)	35+39,5 x 31+35	<b>1R87LPC</b>	<input type="checkbox"/> 46 x 46 - (10 x 10)	44+48,5 x 44+48,5	<b>1R1010LPC</b>
<input type="checkbox"/> 38 x 38 - (8 x 8)	35+39,5 x 35+39,5	<b>1R88LPC</b>	<input type="checkbox"/> 46 x 51 - (10 x 11)	44+48,5 x 48,5+52,5	<b>1R1011LPC</b>
<input type="checkbox"/> 38 x 42 - (8 x 9)	35+39,5 x 39,5+44	<b>1R89LPC</b>	<input type="checkbox"/> 51 x 42 - (11 x 9)	48,5+52,5 x 39,5+44	<b>1R119LPC</b>
<input type="checkbox"/> 38 x 46 - (8 x 10)	35+39,5 x 44+48,5	<b>1R810LPC</b>	<input type="checkbox"/> 51 x 46 - (11 x 10)	48,5+52,5 x 44+48,5	<b>1R1110LPC</b>
<input type="checkbox"/> 42 x 38 - (9 x 8)	39,5+44 x 35+39,5	<b>1R98LPC</b>	<input type="checkbox"/> 51 x 51 - (11 x 11)	48,5+52,5 x 48,5+52,5	<b>1R1111LPC</b>



**ROHO® QUADTRO SELECT® High Profile® altezza 10 cm** **630,00**

Misure cuscino LxP	Adatto a seduta LSxPS	Codice	Misure cuscino LxP	Adatto a seduta LSxPS	Codice
<input type="checkbox"/> 30 x 30 - (6 x 6)	26,5+31 x 26,5+31	<b>QS66C</b>	<input type="checkbox"/> 42 x 46 - (9 x 10)	39,5+44 x 44+48,5	<b>QS910C</b>
<input type="checkbox"/> 30 x 33 - (6 x 7)	26,5+31 x 31+35	<b>QS67C</b>	<input type="checkbox"/> 42 x 51 - (9 x 11)	39,5+44 x 48,5+52,5	<b>QS911C</b>
<input type="checkbox"/> 33 x 33 - (7 x 7)	31+35 x 31+35	<b>QS77C</b>	<input type="checkbox"/> 42 x 56 - (9 x 12)	39,5+44 x 52,5+57	<b>QS912C</b>
<input type="checkbox"/> 33 x 38 - (7 x 8)	31+35 x 35+39,5	<b>QS78C</b>	<input type="checkbox"/> 46 x 38 - (10 x 8)	44+48,5 x 35+39,5	<b>QS108C</b>
<input type="checkbox"/> 33 x 42 - (7 x 9)	31+35 x 39,5+44	<b>QS79C</b>	<input type="checkbox"/> 46 x 42 - (10 x 9)	44+48,5 x 39,5+44	<b>QS109C</b>
<input type="checkbox"/> 38 x 33 - (8 x 7)	35+39,5 x 31+35	<b>QS87C</b>	<input type="checkbox"/> 46 x 46 - (10 x 10)	44+48,5 x 44+48,5	<b>QS1010C</b>
<input type="checkbox"/> 38 x 38 - (8 x 8)	35+39,5 x 35+39,5	<b>QS88C</b>	<input type="checkbox"/> 46 x 51 - (10 x 11)	44+48,5 x 48,5+52,5	<b>QS1011C</b>
<input type="checkbox"/> 38 x 42 - (8 x 9)	35+39,5 x 39,5+44	<b>QS89C</b>	<input type="checkbox"/> 46 x 56 - (10 x 12)	44+48,5 x 52,5+57	<b>QS1012C</b>
<input type="checkbox"/> 38 x 46 - (8 x 10)	35+39,5 x 44+48,5	<b>QS810C</b>	<input type="checkbox"/> 51 x 42 - (11 x 9)	48,5+52,5 x 39,5+44	<b>QS119C</b>
<input type="checkbox"/> 42 x 38 - (9 x 8)	39,5+44 x 35+39,5	<b>QS98C</b>	<input type="checkbox"/> 51 x 46 - (11 x 10)	48,5+52,5 x 44+48,5	<b>QS1110C</b>
<input type="checkbox"/> 42 x 42 - (9 x 9)	39,5+44 x 39,5+44	<b>QS99C</b>	<input type="checkbox"/> 51 x 51 - (11 x 11)	48,5+52,5 x 48,5+52,5	<b>QS1111C</b>



**ROHO® QUADTRO SELECT® Low Profile® altezza 5 cm** **630,00**

Misure cuscino LxP	Adatto a seduta LSxPS	Codice	Misure cuscino LxP	Adatto a seduta LSxPS	Codice
<input type="checkbox"/> 28 x 30 - (5 x 6)	22+26,5 x 26,5+31	<b>QS56LPC</b>	<input type="checkbox"/> 42 x 42 - (9 x 9)	39,5+44 x 39,5+44	<b>QS99LPC</b>
<input type="checkbox"/> 30 x 30 - (6 x 6)	26,5+31 x 26,5+31	<b>QS66LPC</b>	<input type="checkbox"/> 42 x 46 - (9 x 10)	39,5+44 x 44+48,5	<b>QS910LPC</b>
<input type="checkbox"/> 30 x 33 - (6 x 7)	26,5+31 x 31+35	<b>QS67LPC</b>	<input type="checkbox"/> 42 x 51 - (9 x 11)	39,5+44 x 48,5+52,5	<b>QS911LPC</b>
<input type="checkbox"/> 33 x 33 - (7 x 7)	31+35 x 31+35	<b>QS77LPC</b>	<input type="checkbox"/> 46 x 38 - (10 x 8)	44+48,5 x 35+39,5	<b>QS108LPC</b>
<input type="checkbox"/> 33 x 38 - (7 x 8)	31+35 x 35+39,5	<b>QS78LPC</b>	<input type="checkbox"/> 46 x 42 - (10 x 9)	44+48,5 x 39,5+44	<b>QS109LPC</b>
<input type="checkbox"/> 33 x 42 - (7 x 9)	31+35 x 39,5+44	<b>QS79LPC</b>	<input type="checkbox"/> 46 x 46 - (10 x 10)	44+48,5 x 44+48,5	<b>QS1010LPC</b>
<input type="checkbox"/> 38 x 33 - (8 x 7)	35+39,5 x 31+35	<b>QS87LPC</b>	<input type="checkbox"/> 46 x 51 - (10 x 11)	44+48,5 x 48,5+52,5	<b>QS1011LPC</b>
<input type="checkbox"/> 38 x 38 - (8 x 8)	35+39,5 x 35+39,5	<b>QS88LPC</b>	<input type="checkbox"/> 51 x 42 - (11 x 9)	48,5+52,5 x 39,5+44	<b>QS119LPC</b>
<input type="checkbox"/> 38 x 42 - (8 x 9)	35+39,5 x 39,5+44	<b>QS89LPC</b>	<input type="checkbox"/> 51 x 46 - (11 x 10)	48,5+52,5 x 44+48,5	<b>QS1110LPC</b>
<input type="checkbox"/> 38 x 46 - (8 x 10)	35+39,5 x 44+48,5	<b>QS810LPC</b>	<input type="checkbox"/> 51 x 51 - (11 x 11)	48,5+52,5 x 48,5+52,5	<b>QS1111LPC</b>
<input type="checkbox"/> 42 x 38 - (9 x 8)	39,5+44 x 35+39,5	<b>QS98LPC</b>			

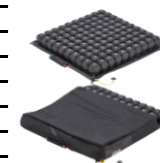

**ROHO® CONTOUR SELECT®** **630,00**

Misure cuscino LxP	Adatto a seduta LSxPS	Codice	Misure cuscino LxP	Adatto a seduta LSxPS	Codice
<input type="checkbox"/> 33 x 38 - (7 x 8)	31+35 x 35+39,5	<b>CS78C</b>	<input type="checkbox"/> 42 x 51 - (9 x 11)	39,5+44 x 48,5+52,5	<b>CS911C</b>
<input type="checkbox"/> 38 x 38 - (8 x 8)	35+39,5 x 35+39,5	<b>CS88C</b>	<input type="checkbox"/> 46 x 42 - (10 x 9)	44+48,5 x 39,5+44	<b>CS109C</b>
<input type="checkbox"/> 38 x 42 - (8 x 9)	35+39,5 x 39,5+44	<b>CS89C</b>	<input type="checkbox"/> 46 x 46 - (10 x 10)	44+48,5 x 44+48,5	<b>CS1010C</b>
<input type="checkbox"/> 38 x 46 - (8 x 10)	35+39,5 x 44+48,5	<b>CS810C</b>	<input type="checkbox"/> 46 x 51 - (10 x 11)	44+48,5 x 48,5+52,5	<b>CS1011C</b>
<input type="checkbox"/> 42 x 38 - (9 x 8)	39,5+44 x 35+39,5	<b>CS98C</b>	<input type="checkbox"/> 51 x 42 - (11 x 9)	48,5+52,5 x 39,5+44	<b>CS119C</b>
<input type="checkbox"/> 42 x 42 - (9 x 9)	39,5+44 x 39,5+44	<b>CS99C</b>	<input type="checkbox"/> 51 x 46 - (11 x 10)	48,5+52,5 x 44+48,5	<b>CS1110C</b>
<input type="checkbox"/> 42 x 46 - (9 x 10)	39,5+44 x 44+48,5	<b>CS910C</b>	<input type="checkbox"/> 51 x 51 - (11 x 11)	48,5+52,5 x 48,5+52,5	<b>CS1111C</b>



**ROHO® ENHANCER®** **630,00**

Misure cuscino LxP	Adatto a seduta LSxPS	Codice	Misure cuscino LxP	Adatto a seduta LSxPS	Codice
<input type="checkbox"/> 38 x 38 - (8 x 8)	35+39,5 x 35+39,5	<b>ENH88C</b>	<input type="checkbox"/> 46 x 42 - (10 x 9)	44+48,5 x 39,5+44	<b>ENH109C</b>
<input type="checkbox"/> 38 x 42 - (8 x 9)	35+39,5 x 39,5+44	<b>ENH89C</b>	<input type="checkbox"/> 46 x 46 - (10 x 10)	44+48,5 x 44+48,5	<b>ENH1010C</b>
<input type="checkbox"/> 42 x 38 - (9 x 8)	39,5+44 x 35+39,5	<b>ENH98C</b>	<input type="checkbox"/> 46 x 51 - (10 x 11)	44+48,5 x 48,5+52,5	<b>ENH1011C</b>
<input type="checkbox"/> 42 x 42 - (9 x 9)	39,5+44 x 39,5+44	<b>ENH99C</b>	<input type="checkbox"/> 51 x 46 - (11 x 10)	48,5+52,5 x 44+48,5	<b>ENH1110C</b>
<input type="checkbox"/> 42 x 46 - (9 x 10)	39,5+44 x 44+48,5	<b>ENH910C</b>			



Carrozzina : Progeo TEKNA TILT 2.0 - Rev. 2026.1



Prezzo IVA esclusa  
da sommare al prezzo di listino

Pagina da inviare se sono stati scelti optional	
<input checked="" type="checkbox"/> standard	(fornito in assenza di altre indicazioni)
<input type="checkbox"/> su richiesta	(senza aggiunta di prezzo)
<input type="checkbox"/> optional	(sommare il prezzo a quello di listino)

Data ..... Commessa ..... Utilizzatore ..... Indirizzo .....

## SMARTDRIVE - compreso di caricabatteria



 <b>SWITCH CONTROL (DX+SX) - EU</b> Funzionamento a due pulsanti	<input type="radio"/> 6 KM/H	MX2-S002	4.000,00
	<input type="radio"/> 9 KM/H	MX2-S005	4.100,00
 <b>SWITCH CONTROL + JACK 3.5 - EU</b> Un pulsante e un ingresso femmina Mono che permette di collegare SmartDrive con un qualsiasi altro dispositivo di comando/guida.	<input type="radio"/> 6 KM/H	MX2-S003	4.000,00
	<input type="radio"/> 9 KM/H	MX2-S006	4.100,00

**Pulsante di comando esterno BUDDY BUTTON**  
 completo di adattatore, set di montaggio e braccio di estensione  
*Disponibile solo con SWITCH CONTROL + JACK 3.5*



MX2-BBB 250,00

### KIT FISSAGGIO TELAIO PIEGHEVOLE

Scegliere kit di fissaggio in funzione della misura delle ruote posteriori della carrozzina

- kit fissaggio telaio pieghevole - ruote posteriori 22" - 24" MX2-443-C
- kit fissaggio telaio pieghevole - ruote posteriori 25" MX2-453-C
- kit fissaggio telaio pieghevole - ruote posteriori 26" MX2-463-C

## Accessori

Borsa da trasporto



MX2SD-BAG 60,00

Maniglia universale imbottita  
*Maniglia universale imbottita*



MX2-986 20,00

## Note

Carrozzina : Progeo TEKNA TILT 2.0 - Rev. 2026.1

Prezzo IVA esclusa  
 da sommare al prezzo di listino

### Pagina da inviare se sono stati scelti optional

- standard** (fornito in assenza di altre indicazioni)
- su richiesta** (senza aggiunta di prezzo)
- optional** (sommare il prezzo a quello di listino)