



Data ..... Comnessa ..... Utilizzatore ..... Indirizzo .....

**Seduta**

☆ Tela sedile con tasca porta oggetti (sotto seduta)

<input type="radio"/> Seduta a fasce tensionabili	08883	220,00
<input type="radio"/> Seduta rigida in carbonio	08336	450,00
<input type="radio"/> Tasca porta oggetti (sotto seduta) [25x11x4,5]	08281	70,00

**CUSTOMIZE COLORS**

**1 Colore telaio**  
(senza aggiunta di prezzo)

☆ Nero opaco

Bianco POLAR

Arancio Opaco

Tekno antracite

Blu notte opaco

Grigio opaco

Rosso opaco

**Colore telaio su richiesta**

Argento brillante

Rosso brillante

Azzurro brillante

Fucsia brillante

Lime brillante

12579    **120,00**

**2 Colore forcella**

☆ Nero opaco

<input type="radio"/> Argento brillante	<input type="radio"/> Azzurro brillante
<input type="radio"/> Bianco POLAR	<input type="radio"/> Fucsia brillante
<input type="radio"/> Rosso brillante	<input type="radio"/> Lime brillante
<input type="radio"/> Tekno antracite	<input type="radio"/> Blu notte opaco
<input type="radio"/> Grigio opaco	<input type="radio"/> Rosso opaco

08342    **70,00**

**3 Colore ruote posteriori**

Abbinabile solo con: Ruote posteriori Superleggera Standard Progeo (22 - 24)

☆ Nero

<input type="radio"/> Argento brillante	<input type="radio"/> Azzurro brillante
<input type="radio"/> Bianco POLAR	<input type="radio"/> Fucsia brillante
<input type="radio"/> Rosso brillante	<input type="radio"/> Lime brillante
<input type="radio"/> Tekno antracite	<input type="radio"/> Blu notte opaco
<input type="radio"/> Grigio opaco	<input type="radio"/> Rosso opaco

04692    **70,00**

**Asse ruote posteriori**

☆ Asse ruote posteriori in alluminio

Asse ruote posteriori in Carbonio *Configurazione più leggera*

07647    **160,00**

**Sistema di regolazione e fissaggio schienale**

<input type="checkbox"/> Schienale con bloccaggio in apertura e chiusura	con regolazione dell'inclinazione da -4° a +16°
<input type="checkbox"/> Schienale con bloccaggio solo in apertura	con regolazione dell'inclinazione da -4° a +16°
<input type="checkbox"/> Schienale fisso (non abbattibile)	con regolazione dell'inclinazione da -4° a +16°

**Schienale**

☆ Imbottitura tensionabile traspirante

☆ Schienale in alluminio		13599	200,00
<input type="radio"/> Schienale in titanio		04389	660,00
<input type="radio"/> Schienale in carbonio			

**AIR** Schienale posturale integrato (NON REMOVIBILE) **860,00**

Guscio CARBONIO - Contenimento laterale 7,5cm  
Regolazione in profondità ±1cm. - Regolazione inclinazione ±10°  
non disponibile per larghezza 48

H 28		H 34		H 40	
Altezza schienale (TS) min 34		Altezza schienale (TS) min 38		Altezza schienale (TS) min 44	
( ..... )		( ..... )		( ..... )	
Ala di contenimento laterale A=alta - R=regolare					
A	R	A	R	A	R
<input type="checkbox"/>	<input type="checkbox"/>	<input type="checkbox"/>	<input type="checkbox"/>	<input type="checkbox"/>	<input type="checkbox"/>

**Installazione su:**

☆ Tubi schienale

Schienale in alluminio

Schienale in titanio

Schienale in carbonio

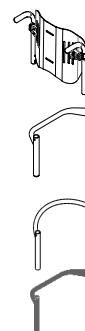

13599    **200,00**

04389    **660,00**



Data .....	Commessa .....	Utilizzatore .....	Indirizzo .....
------------	----------------	--------------------	-----------------

### Pedana

☆ Pedana in alluminio. Non regolabile in inclinazione

☆ Pedana di alluminio

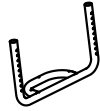

con piatto in plastica

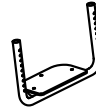

Pedana unica alzabile in alluminio FLIP-BACK! - regolabile in profondità e inclinazione

ATTENZIONE! Altezza anteriore minimo 6 cm maggiore della DISTANZA PEDANA

Con ruota 5" la differenza tra Altezza Anteriore e Altezza posteriore deve essere maggiore di 5cm

Pedana in alluminio - regolabile in profondità e inclinazione

☆ interna     2/3 interna     esterna     2/3 esterna

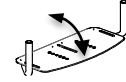

09420    **220,00**



04456    **240,00**



09853    **220,00**

U-TUBE - Pedana in alluminio, regolabile in profondità e inclinazione

**TELAIO BASSO:** distanza pedana minima possibile 18 - distanza pedana massima possibile 35

**TELAIO ALTO:** distanza pedana minima possibile 21 - distanza pedana massima possibile 38

Pedana unica in carbonio. Regolabile in inclinazione

☆ interna     esterna

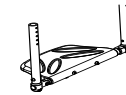

04110    **330,00**

### Braccioli

Braccioli Tubolari (Girevoli estraibili regolabili in altezza)



00694    **250,00**

Braccioli estraibili con protezione dritta in Carbonio  
**Disponibile solo con: Fiancata posteriore standard**



09079    **200,00**

### Accessori

Imbottitura paracolpi telaio anteriore

07058    **50,00**

Patella di raccordo schienale/tela sedile

10241    **20,00**

Borsello portaoggetti removibile (con aggancio rapido)

09811    **120,00**

### Optional 1

**E' possibile inserire solo un optional per lato**

Ruote ascensore    Esclude l'installazione delle Ruote antiribaltamento



03290    **170,00**

Ruota antiribaltamento con aggancio rapido    Esclude l'installazione delle Ruote ascensore (rotazione all'interno per ridurre l'ingombro)

Destra  
 Sinistra



06821    **130,00**

06822    **130,00**

### Optional 2

Maniglie di spinta per accompagnatore (Regolabili in altezza ed estraibili)



13600    **190,00**

Tetraclip (perno estrazione rapida per tetraplegici)

03947    **170,00**

Cinghia pelvica di ancoraggio

03972    **70,00**

Cinghia di bretellaggio

04103    **130,00**

Supporto lombare (da inserire all'interno dello schienale)

00013    **50,00**

Spinta laterale destra    Non disponibile con Schienale posturale PHYSIO - Schienale posturale A I R  
Impedisce l'abbattimento dello schienale

Destra  
 Sinistra



02097    **250,00**

02098    **250,00**

Copriraggi Nero (22"-24")

01043    **160,00**

Copriraggi Trasparente (22"-24")

00835    **160,00**

Copriraggi Colorato Progeo Design (22"-24")

00019    **180,00**

### Kit aggiuntivo

Ruote posteriori 24" Fuoristrada    Copertone Fuoristrada - corrimano in alluminio (colore nero)

03378    **500,00**

Ruote posteriori FAT 24"    Copertone liscio FAT 3" - corrimano in alluminio (colore nero)

09357    **850,00**

Data ..... Comnessa ..... Utilizzatore ..... Indirizzo .....

**PHYSIO - Schienale posturale**  
**(Imbottitura schienale originale non fornita)**

Estraibile con aggancio rapido  
Installazione su tubi diametro 18÷26mm  
Regolazione in profondità (4cm)  
Regolazione inclinazione (±18°)

- AIR** Guscio CARBONIO  
non disponibile per larghezza 48

ALTEZZA SCHIENALE	28	34	40			
Conformazione del guscio 	Ala di contenimento laterale A=alta - R=regolare					
	A	R	A	R	A	R
	<input type="checkbox"/>	<input type="checkbox"/>	<input type="checkbox"/>	<input type="checkbox"/>	<input type="checkbox"/>	<input type="checkbox"/>

860,00

- POSTURE** Guscio ALLUMINIO

ALTEZZA SCHIENALE	34	40	52
Conformazione del guscio 	Ala di contenimento laterale R=regolare		
	R	R	R
	<input type="checkbox"/>	<input type="checkbox"/>	<input type="checkbox"/>

830,00

**Configurazione DEEP con PAD per contenimento laterale (regolabili in altezza)**

Pad in alluminio con imbottitura e rivestimento in tessuto traspirante



Piccolo (h 13cm)



- Destro 10272 40,00  
 Sinistro 10272 40,00

Grande (h 20cm)



- Destro 10273 50,00  
 Sinistro 10273 50,00

**Supporti toracici (spinta laterale) - SWING AWAY - Girevole**

Hardware di fissaggio e regolazione completi di imbottitura paracolpi  
Pad in alluminio con imbottitura e rivestimento in tessuto traspirante

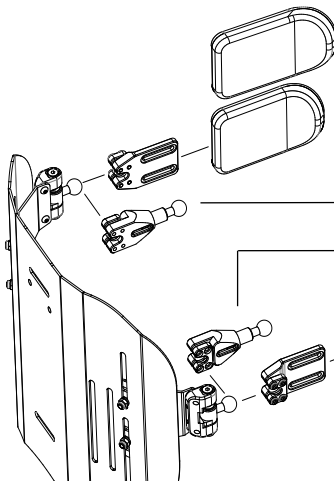

- Grande (18x12) 05647 170,00  
 Piccola (14x9) 05643 170,00  
 Prolunga supporto toracico  
Quantità (n° pz)..... 10271 60,00  
 Prolunga supporto toracico  
Quantità (n° pz).....  
 Piccola (14x9) 05642 170,00  
 Grande (18x12) 05646 170,00

- Poggiatesta multiregolazione - sistema di montaggio a doppia sfera





Disponibile solo su schienale Physio Posture



- Grande (35x12,5) 05648 360,00  
 Piccolo (25x12,5)

Data .....	Commessa .....	Utilizzatore .....	Indirizzo .....
------------	----------------	--------------------	-----------------

**Cuscini antidecubito e posturali a nido d'ape STIMULITE**

<input type="radio"/> Classic H 7 cm.	<input type="checkbox"/> 36x41	00035	<input type="checkbox"/> 38x38	00036	<input type="checkbox"/> 38x41	01052	<input type="checkbox"/> 41x41	00037		<b>630,00</b>
	<input type="checkbox"/> 41x46	00840	<input type="checkbox"/> 46x41	00698	<input type="checkbox"/> 46x46	00038				
<input type="radio"/> Anatomico Posturale H 9 cm. H 5cm. nella zona ischiatica	<input type="checkbox"/> 36x41	00056	<input type="checkbox"/> 38x38	00696	<input type="checkbox"/> 38x41	00032	<input type="checkbox"/> 41x41	00033		<b>630,00</b>
	<input type="checkbox"/> 41x46	01050	<input type="checkbox"/> 46x41	00034	<input type="checkbox"/> 46x46	01051				
<input type="radio"/> Slimline sagomato H 7 cm. H 5cm. nella zona ischiatica	<input type="checkbox"/> 36x41	00854	<input type="checkbox"/> 38x38	00707	<input type="checkbox"/> 38x41	00083	<input type="checkbox"/> 41x41	01073		<b>630,00</b>
	<input type="checkbox"/> 41x46	00085	<input type="checkbox"/> 46x41	01074	<input type="checkbox"/> 46x46	01075				
<input type="radio"/> Sport H 5 cm.	<input type="checkbox"/> 36x41	00053	<input type="checkbox"/> 38x38	00054	<input type="checkbox"/> 38x41	01060	<input type="checkbox"/> 41x41	01061		<b>630,00</b>
	<input type="checkbox"/> 41x46	00057	<input type="checkbox"/> 46x41	01062	<input type="checkbox"/> 46x46	00846				
<input type="radio"/> Silver H 3,5 cm.	<input type="checkbox"/> 41x41	00641	<input type="checkbox"/> 41x46	01353	<input type="checkbox"/> 46x41	00642	<input type="checkbox"/> 46x46	01022		<b>630,00</b>
Misura cliente      Larghezza cm. ....      Profondità cm. ....										







<input type="radio"/> Supporto lombare STIMULITE		00064	<b>220,00</b>
--	---	-------	---------------

**Note**

Carrozzina : Progeo JOKER R2 - Rev. 2026.0	Prezzo IVA esclusa da sommare al prezzo di listino	<table border="1" style="width:100%; border-collapse: collapse;"> <tr> <th colspan="2" style="text-align: left; padding: 2px;">Pagina da inviare se sono stati scelti optional</th> </tr> <tr> <td style="width:10%; text-align: center; padding: 2px;"><input checked="" type="checkbox"/></td> <td style="padding: 2px;">standard (fornito in assenza di altre indicazioni)</td> </tr> <tr> <td style="text-align: center; padding: 2px;"><input type="checkbox"/></td> <td style="padding: 2px;">su richiesta (senza aggiunta di prezzo)</td> </tr> <tr> <td style="text-align: center; padding: 2px;"><input type="radio"/></td> <td style="padding: 2px;">optional (sommare il prezzo a quello di listino)</td> </tr> </table>	Pagina da inviare se sono stati scelti optional		<input checked="" type="checkbox"/>	standard (fornito in assenza di altre indicazioni)	<input type="checkbox"/>	su richiesta (senza aggiunta di prezzo)	<input type="radio"/>	optional (sommare il prezzo a quello di listino)
Pagina da inviare se sono stati scelti optional										
<input checked="" type="checkbox"/>	standard (fornito in assenza di altre indicazioni)									
<input type="checkbox"/>	su richiesta (senza aggiunta di prezzo)									
<input type="radio"/>	optional (sommare il prezzo a quello di listino)									

Permobili Progeo Active Design s.r.l. - a Socio Unico - Vicolo L. Negrelli, 5 - 31038 Paese (TV) - Tel. +39 0422 484657  
 P. IVA, Codice Fiscale e Numero di iscrizione al Registro Imprese di Treviso 10246110988 - Fatturazione Elettronica: Codice Destinatario A4707H7 - Capitale Sociale I.V. € 10.000,00

Email: info\_it@permobili.com - web: http://www.rehateamprogeo.com

Data	Commessa	Utilizzatore	Indirizzo																																																																								
<b>ROHO® MOSAIC® - H7cm - Limite di peso 143Kg</b> <span style="float: right;">200,00</span>																																																																											
<table border="1"> <thead> <tr> <th>Misure cuscino LxP</th> <th>Adatto a seduta LxSxPS</th> <th>Codice</th> </tr> </thead> <tbody> <tr><td><input type="checkbox"/> 41 x 41</td><td>42 x 42</td><td>MOS1616HD</td></tr> <tr><td><input type="checkbox"/> 41 x 46</td><td>42 x 47</td><td>MOS1618HD</td></tr> <tr><td><input type="checkbox"/> 44 x 44</td><td>44 x 44</td><td>MOS1717HD</td></tr> </tbody> </table>	Misure cuscino LxP	Adatto a seduta LxSxPS	Codice	<input type="checkbox"/> 41 x 41	42 x 42	MOS1616HD	<input type="checkbox"/> 41 x 46	42 x 47	MOS1618HD	<input type="checkbox"/> 44 x 44	44 x 44	MOS1717HD	<table border="1"> <thead> <tr> <th>Misure cuscino LxP</th> <th>Adatto a seduta LxSxPS</th> <th>Codice</th> </tr> </thead> <tbody> <tr><td><input type="checkbox"/> 46 x 41</td><td>47 x 42</td><td>MOS1816HD</td></tr> <tr><td><input type="checkbox"/> 46 x 46</td><td>47 x 47</td><td>MOS1818HD</td></tr> <tr><td><input type="checkbox"/> 51 x 46</td><td>52 x 47</td><td>MOS2018HD</td></tr> </tbody> </table>	Misure cuscino LxP	Adatto a seduta LxSxPS	Codice	<input type="checkbox"/> 46 x 41	47 x 42	MOS1816HD	<input type="checkbox"/> 46 x 46	47 x 47	MOS1818HD	<input type="checkbox"/> 51 x 46	52 x 47	MOS2018HD																																																		
Misure cuscino LxP	Adatto a seduta LxSxPS	Codice																																																																									
<input type="checkbox"/> 41 x 41	42 x 42	MOS1616HD																																																																									
<input type="checkbox"/> 41 x 46	42 x 47	MOS1618HD																																																																									
<input type="checkbox"/> 44 x 44	44 x 44	MOS1717HD																																																																									
Misure cuscino LxP	Adatto a seduta LxSxPS	Codice																																																																									
<input type="checkbox"/> 46 x 41	47 x 42	MOS1816HD																																																																									
<input type="checkbox"/> 46 x 46	47 x 47	MOS1818HD																																																																									
<input type="checkbox"/> 51 x 46	52 x 47	MOS2018HD																																																																									
<b>ROHO® AIR LITE® - H9,5cm - Limite di peso 136Kg</b> <span style="float: right;">200,00</span>																																																																											
<table border="1"> <thead> <tr> <th>Misure cuscino LxP</th> <th>Codice</th> </tr> </thead> <tbody> <tr><td><input type="checkbox"/> 33 x 33</td><td>AL1313HD</td></tr> <tr><td><input type="checkbox"/> 33 x 38</td><td>AL1315HD</td></tr> <tr><td><input type="checkbox"/> 36 x 36</td><td>AL1414HD</td></tr> <tr><td><input type="checkbox"/> 36 x 41</td><td>AL1416HD</td></tr> <tr><td><input type="checkbox"/> 38 x 38</td><td>AL1515HD</td></tr> <tr><td><input type="checkbox"/> 38 x 43</td><td>AL1517HD</td></tr> <tr><td><input type="checkbox"/> 41 x 41</td><td>AL1616HD</td></tr> <tr><td><input type="checkbox"/> 41 x 46</td><td>AL1618HD</td></tr> <tr><td><input type="checkbox"/> 43 x 43</td><td>AL1717HD</td></tr> </tbody> </table>	Misure cuscino LxP	Codice	<input type="checkbox"/> 33 x 33	AL1313HD	<input type="checkbox"/> 33 x 38	AL1315HD	<input type="checkbox"/> 36 x 36	AL1414HD	<input type="checkbox"/> 36 x 41	AL1416HD	<input type="checkbox"/> 38 x 38	AL1515HD	<input type="checkbox"/> 38 x 43	AL1517HD	<input type="checkbox"/> 41 x 41	AL1616HD	<input type="checkbox"/> 41 x 46	AL1618HD	<input type="checkbox"/> 43 x 43	AL1717HD	<table border="1"> <thead> <tr> <th>Misure cuscino LxP</th> <th>Codice</th> </tr> </thead> <tbody> <tr><td><input type="checkbox"/> 43 x 46</td><td>AL1718HD</td></tr> <tr><td><input type="checkbox"/> 43 x 51</td><td>AL1720HD</td></tr> <tr><td><input type="checkbox"/> 46 x 41</td><td>AL1816HD</td></tr> <tr><td><input type="checkbox"/> 46 x 46</td><td>AL1818HD</td></tr> <tr><td><input type="checkbox"/> 46 x 51</td><td>AL1820HD</td></tr> <tr><td><input type="checkbox"/> 48 x 43</td><td>AL1917HD</td></tr> <tr><td><input type="checkbox"/> 48 x 48</td><td>AL1919HD</td></tr> <tr><td><input type="checkbox"/> 51 x 43</td><td>AL2017HD</td></tr> <tr><td><input type="checkbox"/> 51 x 46</td><td>AL2018HD</td></tr> </tbody> </table>	Misure cuscino LxP	Codice	<input type="checkbox"/> 43 x 46	AL1718HD	<input type="checkbox"/> 43 x 51	AL1720HD	<input type="checkbox"/> 46 x 41	AL1816HD	<input type="checkbox"/> 46 x 46	AL1818HD	<input type="checkbox"/> 46 x 51	AL1820HD	<input type="checkbox"/> 48 x 43	AL1917HD	<input type="checkbox"/> 48 x 48	AL1919HD	<input type="checkbox"/> 51 x 43	AL2017HD	<input type="checkbox"/> 51 x 46	AL2018HD																																		
Misure cuscino LxP	Codice																																																																										
<input type="checkbox"/> 33 x 33	AL1313HD																																																																										
<input type="checkbox"/> 33 x 38	AL1315HD																																																																										
<input type="checkbox"/> 36 x 36	AL1414HD																																																																										
<input type="checkbox"/> 36 x 41	AL1416HD																																																																										
<input type="checkbox"/> 38 x 38	AL1515HD																																																																										
<input type="checkbox"/> 38 x 43	AL1517HD																																																																										
<input type="checkbox"/> 41 x 41	AL1616HD																																																																										
<input type="checkbox"/> 41 x 46	AL1618HD																																																																										
<input type="checkbox"/> 43 x 43	AL1717HD																																																																										
Misure cuscino LxP	Codice																																																																										
<input type="checkbox"/> 43 x 46	AL1718HD																																																																										
<input type="checkbox"/> 43 x 51	AL1720HD																																																																										
<input type="checkbox"/> 46 x 41	AL1816HD																																																																										
<input type="checkbox"/> 46 x 46	AL1818HD																																																																										
<input type="checkbox"/> 46 x 51	AL1820HD																																																																										
<input type="checkbox"/> 48 x 43	AL1917HD																																																																										
<input type="checkbox"/> 48 x 48	AL1919HD																																																																										
<input type="checkbox"/> 51 x 43	AL2017HD																																																																										
<input type="checkbox"/> 51 x 46	AL2018HD																																																																										
<b>ROHO® HYBRID ELITE SR® - Monovalvola - Sensor Ready - Limite di peso 225Kg</b> <span style="float: right;">630,00</span>																																																																											
<table border="1"> <thead> <tr> <th>Misure cuscino LxP</th> <th>Adatto a seduta LxSxPS</th> <th>Codice</th> </tr> </thead> <tbody> <tr><td><input type="checkbox"/> 35 x 37,5</td><td>36 x 36</td><td>1RHE1414C-SR</td></tr> <tr><td><input type="checkbox"/> 35 x 40</td><td>36 x 38</td><td>1RHE1415C-SR</td></tr> <tr><td><input type="checkbox"/> 35 x 43</td><td>36 x 41</td><td>1RHE1416C-SR</td></tr> <tr><td><input type="checkbox"/> 37,5 x 40</td><td>38 x 38</td><td>1RHE1515C-SR</td></tr> <tr><td><input type="checkbox"/> 37,5 x 43</td><td>38 x 41</td><td>1RHE1516C-SR</td></tr> <tr><td><input type="checkbox"/> 37,5 x 45</td><td>38 x 43</td><td>1RHE1517C-SR</td></tr> <tr><td><input type="checkbox"/> 40 x 40</td><td>41 x 38</td><td>1RHE1615C-SR</td></tr> <tr><td><input type="checkbox"/> 40 x 43</td><td>41 x 41</td><td>1RHE1616C-SR</td></tr> <tr><td><input type="checkbox"/> 40 x 45</td><td>41 x 43</td><td>1RHE1617C-SR</td></tr> <tr><td><input type="checkbox"/> 40 x 48</td><td>41 x 46</td><td>1RHE1618C-SR</td></tr> <tr><td><input type="checkbox"/> 40 x 53</td><td>41 x 51</td><td>1RHE1620C-SR</td></tr> </tbody> </table>	Misure cuscino LxP	Adatto a seduta LxSxPS	Codice	<input type="checkbox"/> 35 x 37,5	36 x 36	1RHE1414C-SR	<input type="checkbox"/> 35 x 40	36 x 38	1RHE1415C-SR	<input type="checkbox"/> 35 x 43	36 x 41	1RHE1416C-SR	<input type="checkbox"/> 37,5 x 40	38 x 38	1RHE1515C-SR	<input type="checkbox"/> 37,5 x 43	38 x 41	1RHE1516C-SR	<input type="checkbox"/> 37,5 x 45	38 x 43	1RHE1517C-SR	<input type="checkbox"/> 40 x 40	41 x 38	1RHE1615C-SR	<input type="checkbox"/> 40 x 43	41 x 41	1RHE1616C-SR	<input type="checkbox"/> 40 x 45	41 x 43	1RHE1617C-SR	<input type="checkbox"/> 40 x 48	41 x 46	1RHE1618C-SR	<input type="checkbox"/> 40 x 53	41 x 51	1RHE1620C-SR	<table border="1"> <thead> <tr> <th>Misure cuscino LxP</th> <th>Adatto a seduta LxSxPS</th> <th>Codice</th> </tr> </thead> <tbody> <tr><td><input type="checkbox"/> 43 x 43</td><td>43 x 41</td><td>1RHE1716C-SR</td></tr> <tr><td><input type="checkbox"/> 43 x 45</td><td>43 x 43</td><td>1RHE1717C-SR</td></tr> <tr><td><input type="checkbox"/> 43 x 48</td><td>43 x 46</td><td>1RHE1718C-SR</td></tr> <tr><td><input type="checkbox"/> 43 x 53</td><td>43 x 51</td><td>1RHE1720C-SR</td></tr> <tr><td><input type="checkbox"/> 45 x 43</td><td>46 x 41</td><td>1RHE1816C-SR</td></tr> <tr><td><input type="checkbox"/> 45 x 45</td><td>46 x 43</td><td>1RHE1817C-SR</td></tr> <tr><td><input type="checkbox"/> 45 x 48</td><td>46 x 46</td><td>1RHE1818C-SR</td></tr> <tr><td><input type="checkbox"/> 45 x 53</td><td>46 x 51</td><td>1RHE1820C-SR</td></tr> <tr><td><input type="checkbox"/> 50 x 45</td><td>51 x 43</td><td>1RHE2017C-SR</td></tr> <tr><td><input type="checkbox"/> 50 x 48</td><td>51 x 46</td><td>1RHE2018C-SR</td></tr> <tr><td><input type="checkbox"/> 50 x 53</td><td>51 x 51</td><td>1RHE2020C-SR</td></tr> </tbody> </table>	Misure cuscino LxP	Adatto a seduta LxSxPS	Codice	<input type="checkbox"/> 43 x 43	43 x 41	1RHE1716C-SR	<input type="checkbox"/> 43 x 45	43 x 43	1RHE1717C-SR	<input type="checkbox"/> 43 x 48	43 x 46	1RHE1718C-SR	<input type="checkbox"/> 43 x 53	43 x 51	1RHE1720C-SR	<input type="checkbox"/> 45 x 43	46 x 41	1RHE1816C-SR	<input type="checkbox"/> 45 x 45	46 x 43	1RHE1817C-SR	<input type="checkbox"/> 45 x 48	46 x 46	1RHE1818C-SR	<input type="checkbox"/> 45 x 53	46 x 51	1RHE1820C-SR	<input type="checkbox"/> 50 x 45	51 x 43	1RHE2017C-SR	<input type="checkbox"/> 50 x 48	51 x 46	1RHE2018C-SR	<input type="checkbox"/> 50 x 53	51 x 51	1RHE2020C-SR		
Misure cuscino LxP	Adatto a seduta LxSxPS	Codice																																																																									
<input type="checkbox"/> 35 x 37,5	36 x 36	1RHE1414C-SR																																																																									
<input type="checkbox"/> 35 x 40	36 x 38	1RHE1415C-SR																																																																									
<input type="checkbox"/> 35 x 43	36 x 41	1RHE1416C-SR																																																																									
<input type="checkbox"/> 37,5 x 40	38 x 38	1RHE1515C-SR																																																																									
<input type="checkbox"/> 37,5 x 43	38 x 41	1RHE1516C-SR																																																																									
<input type="checkbox"/> 37,5 x 45	38 x 43	1RHE1517C-SR																																																																									
<input type="checkbox"/> 40 x 40	41 x 38	1RHE1615C-SR																																																																									
<input type="checkbox"/> 40 x 43	41 x 41	1RHE1616C-SR																																																																									
<input type="checkbox"/> 40 x 45	41 x 43	1RHE1617C-SR																																																																									
<input type="checkbox"/> 40 x 48	41 x 46	1RHE1618C-SR																																																																									
<input type="checkbox"/> 40 x 53	41 x 51	1RHE1620C-SR																																																																									
Misure cuscino LxP	Adatto a seduta LxSxPS	Codice																																																																									
<input type="checkbox"/> 43 x 43	43 x 41	1RHE1716C-SR																																																																									
<input type="checkbox"/> 43 x 45	43 x 43	1RHE1717C-SR																																																																									
<input type="checkbox"/> 43 x 48	43 x 46	1RHE1718C-SR																																																																									
<input type="checkbox"/> 43 x 53	43 x 51	1RHE1720C-SR																																																																									
<input type="checkbox"/> 45 x 43	46 x 41	1RHE1816C-SR																																																																									
<input type="checkbox"/> 45 x 45	46 x 43	1RHE1817C-SR																																																																									
<input type="checkbox"/> 45 x 48	46 x 46	1RHE1818C-SR																																																																									
<input type="checkbox"/> 45 x 53	46 x 51	1RHE1820C-SR																																																																									
<input type="checkbox"/> 50 x 45	51 x 43	1RHE2017C-SR																																																																									
<input type="checkbox"/> 50 x 48	51 x 46	1RHE2018C-SR																																																																									
<input type="checkbox"/> 50 x 53	51 x 51	1RHE2020C-SR																																																																									
<b>ROHO® HYBRID ELITE® - Bivalvola /Bicompartimento - Limite di peso 225Kg</b> <span style="float: right;">630,00</span>																																																																											
<table border="1"> <thead> <tr> <th>Misure cuscino LxP</th> <th>Adatto a seduta LxSxPS</th> <th>Codice</th> </tr> </thead> <tbody> <tr><td><input type="checkbox"/> 35 x 37,5</td><td>36 x 36</td><td>2RHE1414C</td></tr> <tr><td><input type="checkbox"/> 35 x 40</td><td>36 x 38</td><td>2RHE1415C</td></tr> <tr><td><input type="checkbox"/> 35 x 43</td><td>36 x 41</td><td>2RHE1416C</td></tr> <tr><td><input type="checkbox"/> 37,5 x 40</td><td>38 x 38</td><td>2RHE1515C</td></tr> <tr><td><input type="checkbox"/> 37,5 x 43</td><td>38 x 41</td><td>2RHE1516C</td></tr> <tr><td><input type="checkbox"/> 37,5 x 45</td><td>38 x 43</td><td>2RHE1517C</td></tr> <tr><td><input type="checkbox"/> 40 x 40</td><td>41 x 38</td><td>2RHE1615C</td></tr> <tr><td><input type="checkbox"/> 40 x 43</td><td>41 x 41</td><td>2RHE1616C</td></tr> <tr><td><input type="checkbox"/> 40 x 45</td><td>41 x 43</td><td>2RHE1617C</td></tr> <tr><td><input type="checkbox"/> 40 x 48</td><td>41 x 46</td><td>2RHE1618C</td></tr> <tr><td><input type="checkbox"/> 40 x 53</td><td>41 x 51</td><td>2RHE1620C</td></tr> </tbody> </table>	Misure cuscino LxP	Adatto a seduta LxSxPS	Codice	<input type="checkbox"/> 35 x 37,5	36 x 36	2RHE1414C	<input type="checkbox"/> 35 x 40	36 x 38	2RHE1415C	<input type="checkbox"/> 35 x 43	36 x 41	2RHE1416C	<input type="checkbox"/> 37,5 x 40	38 x 38	2RHE1515C	<input type="checkbox"/> 37,5 x 43	38 x 41	2RHE1516C	<input type="checkbox"/> 37,5 x 45	38 x 43	2RHE1517C	<input type="checkbox"/> 40 x 40	41 x 38	2RHE1615C	<input type="checkbox"/> 40 x 43	41 x 41	2RHE1616C	<input type="checkbox"/> 40 x 45	41 x 43	2RHE1617C	<input type="checkbox"/> 40 x 48	41 x 46	2RHE1618C	<input type="checkbox"/> 40 x 53	41 x 51	2RHE1620C	<table border="1"> <thead> <tr> <th>Misure cuscino LxP</th> <th>Adatto a seduta LxSxPS</th> <th>Codice</th> </tr> </thead> <tbody> <tr><td><input type="checkbox"/> 43 x 43</td><td>43 x 41</td><td>2RHE1716C</td></tr> <tr><td><input type="checkbox"/> 43 x 45</td><td>43 x 43</td><td>2RHE1717C</td></tr> <tr><td><input type="checkbox"/> 43 x 48</td><td>43 x 46</td><td>2RHE1718C</td></tr> <tr><td><input type="checkbox"/> 43 x 53</td><td>43 x 51</td><td>2RHE1720C</td></tr> <tr><td><input type="checkbox"/> 45 x 43</td><td>46 x 41</td><td>2RHE1816C</td></tr> <tr><td><input type="checkbox"/> 45 x 45</td><td>46 x 43</td><td>2RHE1817C</td></tr> <tr><td><input type="checkbox"/> 45 x 48</td><td>46 x 46</td><td>2RHE1818C</td></tr> <tr><td><input type="checkbox"/> 45 x 53</td><td>46 x 51</td><td>2RHE1820C</td></tr> <tr><td><input type="checkbox"/> 50 x 45</td><td>51 x 43</td><td>2RHE2017C</td></tr> <tr><td><input type="checkbox"/> 50 x 48</td><td>51 x 46</td><td>2RHE2018C</td></tr> <tr><td><input type="checkbox"/> 50 x 53</td><td>51 x 51</td><td>2RHE2020C</td></tr> </tbody> </table>	Misure cuscino LxP	Adatto a seduta LxSxPS	Codice	<input type="checkbox"/> 43 x 43	43 x 41	2RHE1716C	<input type="checkbox"/> 43 x 45	43 x 43	2RHE1717C	<input type="checkbox"/> 43 x 48	43 x 46	2RHE1718C	<input type="checkbox"/> 43 x 53	43 x 51	2RHE1720C	<input type="checkbox"/> 45 x 43	46 x 41	2RHE1816C	<input type="checkbox"/> 45 x 45	46 x 43	2RHE1817C	<input type="checkbox"/> 45 x 48	46 x 46	2RHE1818C	<input type="checkbox"/> 45 x 53	46 x 51	2RHE1820C	<input type="checkbox"/> 50 x 45	51 x 43	2RHE2017C	<input type="checkbox"/> 50 x 48	51 x 46	2RHE2018C	<input type="checkbox"/> 50 x 53	51 x 51	2RHE2020C		
Misure cuscino LxP	Adatto a seduta LxSxPS	Codice																																																																									
<input type="checkbox"/> 35 x 37,5	36 x 36	2RHE1414C																																																																									
<input type="checkbox"/> 35 x 40	36 x 38	2RHE1415C																																																																									
<input type="checkbox"/> 35 x 43	36 x 41	2RHE1416C																																																																									
<input type="checkbox"/> 37,5 x 40	38 x 38	2RHE1515C																																																																									
<input type="checkbox"/> 37,5 x 43	38 x 41	2RHE1516C																																																																									
<input type="checkbox"/> 37,5 x 45	38 x 43	2RHE1517C																																																																									
<input type="checkbox"/> 40 x 40	41 x 38	2RHE1615C																																																																									
<input type="checkbox"/> 40 x 43	41 x 41	2RHE1616C																																																																									
<input type="checkbox"/> 40 x 45	41 x 43	2RHE1617C																																																																									
<input type="checkbox"/> 40 x 48	41 x 46	2RHE1618C																																																																									
<input type="checkbox"/> 40 x 53	41 x 51	2RHE1620C																																																																									
Misure cuscino LxP	Adatto a seduta LxSxPS	Codice																																																																									
<input type="checkbox"/> 43 x 43	43 x 41	2RHE1716C																																																																									
<input type="checkbox"/> 43 x 45	43 x 43	2RHE1717C																																																																									
<input type="checkbox"/> 43 x 48	43 x 46	2RHE1718C																																																																									
<input type="checkbox"/> 43 x 53	43 x 51	2RHE1720C																																																																									
<input type="checkbox"/> 45 x 43	46 x 41	2RHE1816C																																																																									
<input type="checkbox"/> 45 x 45	46 x 43	2RHE1817C																																																																									
<input type="checkbox"/> 45 x 48	46 x 46	2RHE1818C																																																																									
<input type="checkbox"/> 45 x 53	46 x 51	2RHE1820C																																																																									
<input type="checkbox"/> 50 x 45	51 x 43	2RHE2017C																																																																									
<input type="checkbox"/> 50 x 48	51 x 46	2RHE2018C																																																																									
<input type="checkbox"/> 50 x 53	51 x 51	2RHE2020C																																																																									
<b>ROHO® HYBRID SELECT®</b> <span style="float: right;">630,00</span>																																																																											
<table border="1"> <thead> <tr> <th>Misure cuscino LxP</th> <th>Adatto a seduta LxSxPS</th> <th>Codice</th> </tr> </thead> <tbody> <tr><td><input type="checkbox"/> 35,5 x 37,5</td><td>36x38</td><td>HS1414C</td></tr> <tr><td><input type="checkbox"/> 35,5 x 42,5</td><td>36x43</td><td>HS1416C</td></tr> <tr><td><input type="checkbox"/> 38 x 40</td><td>38x40</td><td>HS1515C</td></tr> <tr><td><input type="checkbox"/> 38 x 42,5</td><td>38x43</td><td>HS1516C</td></tr> <tr><td><input type="checkbox"/> 38 x 45</td><td>38x45</td><td>HS1517C</td></tr> <tr><td><input type="checkbox"/> 40,5 x 40</td><td>41x40</td><td>HS1615C</td></tr> <tr><td><input type="checkbox"/> 40,5 x 42,5</td><td>41x43</td><td>HS1616C</td></tr> <tr><td><input type="checkbox"/> 40,5 x 45</td><td>41x45</td><td>HS1617C</td></tr> <tr><td><input type="checkbox"/> 40,5 x 47,5</td><td>41x48</td><td>HS1618C</td></tr> <tr><td><input type="checkbox"/> 40,5 x 52,5</td><td>41x53</td><td>HS1620C</td></tr> <tr><td><input type="checkbox"/> 43 x 42,5</td><td>43x43</td><td>HS1716C</td></tr> </tbody> </table>	Misure cuscino LxP	Adatto a seduta LxSxPS	Codice	<input type="checkbox"/> 35,5 x 37,5	36x38	HS1414C	<input type="checkbox"/> 35,5 x 42,5	36x43	HS1416C	<input type="checkbox"/> 38 x 40	38x40	HS1515C	<input type="checkbox"/> 38 x 42,5	38x43	HS1516C	<input type="checkbox"/> 38 x 45	38x45	HS1517C	<input type="checkbox"/> 40,5 x 40	41x40	HS1615C	<input type="checkbox"/> 40,5 x 42,5	41x43	HS1616C	<input type="checkbox"/> 40,5 x 45	41x45	HS1617C	<input type="checkbox"/> 40,5 x 47,5	41x48	HS1618C	<input type="checkbox"/> 40,5 x 52,5	41x53	HS1620C	<input type="checkbox"/> 43 x 42,5	43x43	HS1716C	<table border="1"> <thead> <tr> <th>Misure cuscino LxP</th> <th>Adatto a seduta LxSxPS</th> <th>Codice</th> </tr> </thead> <tbody> <tr><td><input type="checkbox"/> 43 x 45</td><td>43x45</td><td>HS1717C</td></tr> <tr><td><input type="checkbox"/> 43 x 47,5</td><td>43x48</td><td>HS1718C</td></tr> <tr><td><input type="checkbox"/> 43 x 52,5</td><td>43x53</td><td>HS1720C</td></tr> <tr><td><input type="checkbox"/> 45,5 x 42,5</td><td>46x43</td><td>HS1816C</td></tr> <tr><td><input type="checkbox"/> 45,5 x 45</td><td>46x45</td><td>HS1817C</td></tr> <tr><td><input type="checkbox"/> 45,5 x 47,5</td><td>46x48</td><td>HS1818C</td></tr> <tr><td><input type="checkbox"/> 45,5 x 52,5</td><td>46x53</td><td>HS1820C</td></tr> <tr><td><input type="checkbox"/> 51 x 42,5</td><td>51x43</td><td>HS2016C</td></tr> <tr><td><input type="checkbox"/> 51 x 45</td><td>51x45</td><td>HS2017C</td></tr> <tr><td><input type="checkbox"/> 51 x 47,5</td><td>51x48</td><td>HS2018C</td></tr> <tr><td><input type="checkbox"/> 51 x 52,5</td><td>51x53</td><td>HS2020C</td></tr> </tbody> </table>	Misure cuscino LxP	Adatto a seduta LxSxPS	Codice	<input type="checkbox"/> 43 x 45	43x45	HS1717C	<input type="checkbox"/> 43 x 47,5	43x48	HS1718C	<input type="checkbox"/> 43 x 52,5	43x53	HS1720C	<input type="checkbox"/> 45,5 x 42,5	46x43	HS1816C	<input type="checkbox"/> 45,5 x 45	46x45	HS1817C	<input type="checkbox"/> 45,5 x 47,5	46x48	HS1818C	<input type="checkbox"/> 45,5 x 52,5	46x53	HS1820C	<input type="checkbox"/> 51 x 42,5	51x43	HS2016C	<input type="checkbox"/> 51 x 45	51x45	HS2017C	<input type="checkbox"/> 51 x 47,5	51x48	HS2018C	<input type="checkbox"/> 51 x 52,5	51x53	HS2020C		
Misure cuscino LxP	Adatto a seduta LxSxPS	Codice																																																																									
<input type="checkbox"/> 35,5 x 37,5	36x38	HS1414C																																																																									
<input type="checkbox"/> 35,5 x 42,5	36x43	HS1416C																																																																									
<input type="checkbox"/> 38 x 40	38x40	HS1515C																																																																									
<input type="checkbox"/> 38 x 42,5	38x43	HS1516C																																																																									
<input type="checkbox"/> 38 x 45	38x45	HS1517C																																																																									
<input type="checkbox"/> 40,5 x 40	41x40	HS1615C																																																																									
<input type="checkbox"/> 40,5 x 42,5	41x43	HS1616C																																																																									
<input type="checkbox"/> 40,5 x 45	41x45	HS1617C																																																																									
<input type="checkbox"/> 40,5 x 47,5	41x48	HS1618C																																																																									
<input type="checkbox"/> 40,5 x 52,5	41x53	HS1620C																																																																									
<input type="checkbox"/> 43 x 42,5	43x43	HS1716C																																																																									
Misure cuscino LxP	Adatto a seduta LxSxPS	Codice																																																																									
<input type="checkbox"/> 43 x 45	43x45	HS1717C																																																																									
<input type="checkbox"/> 43 x 47,5	43x48	HS1718C																																																																									
<input type="checkbox"/> 43 x 52,5	43x53	HS1720C																																																																									
<input type="checkbox"/> 45,5 x 42,5	46x43	HS1816C																																																																									
<input type="checkbox"/> 45,5 x 45	46x45	HS1817C																																																																									
<input type="checkbox"/> 45,5 x 47,5	46x48	HS1818C																																																																									
<input type="checkbox"/> 45,5 x 52,5	46x53	HS1820C																																																																									
<input type="checkbox"/> 51 x 42,5	51x43	HS2016C																																																																									
<input type="checkbox"/> 51 x 45	51x45	HS2017C																																																																									
<input type="checkbox"/> 51 x 47,5	51x48	HS2018C																																																																									
<input type="checkbox"/> 51 x 52,5	51x53	HS2020C																																																																									
<b>ROHO® MONOCOMPARTIMENT® High Profile® altezza 10 cm</b> <span style="float: right;">370,00</span>																																																																											
<table border="1"> <thead> <tr> <th>Misure cuscino LxP</th> <th>Adatto a seduta LxSxPS</th> <th>Codice</th> </tr> </thead> <tbody> <tr><td><input type="checkbox"/> 30 x 30 - (6 x 6)</td><td>26,5+31 x 26,5+31</td><td>1R66C</td></tr> <tr><td><input type="checkbox"/> 30 x 33 - (6 x 7)</td><td>26,5+31 x 31+35</td><td>1R67C</td></tr> <tr><td><input type="checkbox"/> 33 x 33 - (7 x 7)</td><td>31+35 x 31+35</td><td>1R77C</td></tr> <tr><td><input type="checkbox"/> 33 x 38 - (7 x 8)</td><td>31+35 x 35+39,5</td><td>1R78C</td></tr> <tr><td><input type="checkbox"/> 33 x 42 - (7 x 9)</td><td>31+35 x 39,5+44</td><td>1R79C</td></tr> <tr><td><input type="checkbox"/> 38 x 33 - (8 x 7)</td><td>35+39,5 x 31+35</td><td>1R87C</td></tr> <tr><td><input type="checkbox"/> 38 x 38 - (8 x 8)</td><td>35+39,5 x 35+39,5</td><td>1R88C</td></tr> <tr><td><input type="checkbox"/> 38 x 42 - (8 x 9)</td><td>35+39,5 x 39,5+44</td><td>1R89C</td></tr> <tr><td><input type="checkbox"/> 38 x 46 - (8 x 10)</td><td>35+39,5 x 44+48,5</td><td>1R810C</td></tr> <tr><td><input type="checkbox"/> 42 x 38 - (9 x 8)</td><td>39,5+44 x 35+39,5</td><td>1R98C</td></tr> <tr><td><input type="checkbox"/> 42 x 42 - (9 x 9)</td><td>39,5+44 x 39,5+44</td><td>1R99C</td></tr> </tbody> </table>	Misure cuscino LxP	Adatto a seduta LxSxPS	Codice	<input type="checkbox"/> 30 x 30 - (6 x 6)	26,5+31 x 26,5+31	1R66C	<input type="checkbox"/> 30 x 33 - (6 x 7)	26,5+31 x 31+35	1R67C	<input type="checkbox"/> 33 x 33 - (7 x 7)	31+35 x 31+35	1R77C	<input type="checkbox"/> 33 x 38 - (7 x 8)	31+35 x 35+39,5	1R78C	<input type="checkbox"/> 33 x 42 - (7 x 9)	31+35 x 39,5+44	1R79C	<input type="checkbox"/> 38 x 33 - (8 x 7)	35+39,5 x 31+35	1R87C	<input type="checkbox"/> 38 x 38 - (8 x 8)	35+39,5 x 35+39,5	1R88C	<input type="checkbox"/> 38 x 42 - (8 x 9)	35+39,5 x 39,5+44	1R89C	<input type="checkbox"/> 38 x 46 - (8 x 10)	35+39,5 x 44+48,5	1R810C	<input type="checkbox"/> 42 x 38 - (9 x 8)	39,5+44 x 35+39,5	1R98C	<input type="checkbox"/> 42 x 42 - (9 x 9)	39,5+44 x 39,5+44	1R99C	<table border="1"> <thead> <tr> <th>Misure cuscino LxP</th> <th>Adatto a seduta LxSxPS</th> <th>Codice</th> </tr> </thead> <tbody> <tr><td><input type="checkbox"/> 42 x 46 - (9 x 10)</td><td>39,5+44 x 44+48,5</td><td>1R910C</td></tr> <tr><td><input type="checkbox"/> 42 x 51 - (9 x 11)</td><td>39,5+44 x 48,5+52,5</td><td>1R911C</td></tr> <tr><td><input type="checkbox"/> 46 x 38 - (10 x 8)</td><td>44+48,5 x 35+39,5</td><td>1R108C</td></tr> <tr><td><input type="checkbox"/> 46 x 42 - (10 x 9)</td><td>44+48,5 x 39,5+44</td><td>1R109C</td></tr> <tr><td><input type="checkbox"/> 46 x 46 - (10 x 10)</td><td>44+48,5 x 44+48,5</td><td>1R1010C</td></tr> <tr><td><input type="checkbox"/> 46 x 51 - (10 x 11)</td><td>44+48,5 x 48,5+52,5</td><td>1R1011C</td></tr> <tr><td><input type="checkbox"/> 46 x 56 - (10 x 12)</td><td>44+48,5 x 52,5+57</td><td>1R1012C</td></tr> <tr><td><input type="checkbox"/> 51 x 42 - (11 x 9)</td><td>48,5+52,5 x 39,5+44</td><td>1R119C</td></tr> <tr><td><input type="checkbox"/> 51 x 46 - (11 x 10)</td><td>48,5+52,5 x 44+48,5</td><td>1R1110C</td></tr> <tr><td><input type="checkbox"/> 51 x 51 - (11 x 11)</td><td>48,5+52,5 x 48,5+52,5</td><td>1R1111C</td></tr> <tr><td><input type="checkbox"/> 51 x 56 - (11 x 12)</td><td>48,5+52,5 x 52,5+57</td><td>1R1112C</td></tr> </tbody> </table>	Misure cuscino LxP	Adatto a seduta LxSxPS	Codice	<input type="checkbox"/> 42 x 46 - (9 x 10)	39,5+44 x 44+48,5	1R910C	<input type="checkbox"/> 42 x 51 - (9 x 11)	39,5+44 x 48,5+52,5	1R911C	<input type="checkbox"/> 46 x 38 - (10 x 8)	44+48,5 x 35+39,5	1R108C	<input type="checkbox"/> 46 x 42 - (10 x 9)	44+48,5 x 39,5+44	1R109C	<input type="checkbox"/> 46 x 46 - (10 x 10)	44+48,5 x 44+48,5	1R1010C	<input type="checkbox"/> 46 x 51 - (10 x 11)	44+48,5 x 48,5+52,5	1R1011C	<input type="checkbox"/> 46 x 56 - (10 x 12)	44+48,5 x 52,5+57	1R1012C	<input type="checkbox"/> 51 x 42 - (11 x 9)	48,5+52,5 x 39,5+44	1R119C	<input type="checkbox"/> 51 x 46 - (11 x 10)	48,5+52,5 x 44+48,5	1R1110C	<input type="checkbox"/> 51 x 51 - (11 x 11)	48,5+52,5 x 48,5+52,5	1R1111C	<input type="checkbox"/> 51 x 56 - (11 x 12)	48,5+52,5 x 52,5+57	1R1112C		
Misure cuscino LxP	Adatto a seduta LxSxPS	Codice																																																																									
<input type="checkbox"/> 30 x 30 - (6 x 6)	26,5+31 x 26,5+31	1R66C																																																																									
<input type="checkbox"/> 30 x 33 - (6 x 7)	26,5+31 x 31+35	1R67C																																																																									
<input type="checkbox"/> 33 x 33 - (7 x 7)	31+35 x 31+35	1R77C																																																																									
<input type="checkbox"/> 33 x 38 - (7 x 8)	31+35 x 35+39,5	1R78C																																																																									
<input type="checkbox"/> 33 x 42 - (7 x 9)	31+35 x 39,5+44	1R79C																																																																									
<input type="checkbox"/> 38 x 33 - (8 x 7)	35+39,5 x 31+35	1R87C																																																																									
<input type="checkbox"/> 38 x 38 - (8 x 8)	35+39,5 x 35+39,5	1R88C																																																																									
<input type="checkbox"/> 38 x 42 - (8 x 9)	35+39,5 x 39,5+44	1R89C																																																																									
<input type="checkbox"/> 38 x 46 - (8 x 10)	35+39,5 x 44+48,5	1R810C																																																																									
<input type="checkbox"/> 42 x 38 - (9 x 8)	39,5+44 x 35+39,5	1R98C																																																																									
<input type="checkbox"/> 42 x 42 - (9 x 9)	39,5+44 x 39,5+44	1R99C																																																																									
Misure cuscino LxP	Adatto a seduta LxSxPS	Codice																																																																									
<input type="checkbox"/> 42 x 46 - (9 x 10)	39,5+44 x 44+48,5	1R910C																																																																									
<input type="checkbox"/> 42 x 51 - (9 x 11)	39,5+44 x 48,5+52,5	1R911C																																																																									
<input type="checkbox"/> 46 x 38 - (10 x 8)	44+48,5 x 35+39,5	1R108C																																																																									
<input type="checkbox"/> 46 x 42 - (10 x 9)	44+48,5 x 39,5+44	1R109C																																																																									
<input type="checkbox"/> 46 x 46 - (10 x 10)	44+48,5 x 44+48,5	1R1010C																																																																									
<input type="checkbox"/> 46 x 51 - (10 x 11)	44+48,5 x 48,5+52,5	1R1011C																																																																									
<input type="checkbox"/> 46 x 56 - (10 x 12)	44+48,5 x 52,5+57	1R1012C																																																																									
<input type="checkbox"/> 51 x 42 - (11 x 9)	48,5+52,5 x 39,5+44	1R119C																																																																									
<input type="checkbox"/> 51 x 46 - (11 x 10)	48,5+52,5 x 44+48,5	1R1110C																																																																									
<input type="checkbox"/> 51 x 51 - (11 x 11)	48,5+52,5 x 48,5+52,5	1R1111C																																																																									
<input type="checkbox"/> 51 x 56 - (11 x 12)	48,5+52,5 x 52,5+57	1R1112C																																																																									

Permobili Progeo Active Design s.r.l. - a Socio Unico - Vicolo L. Negrelli, 5 - 31038 Paese (TV) - Tel. +39 0422 484657  
 P. IVA, Codice Fiscale e Numero di iscrizione al Registro Imprese di Treviso 10246110968 - Fatturazione Elettronica: Codice Destinatario A4707H7 - Capitale Sociale I.V. € 10.000,00

Email: info\_fi@permobili.com - web: http://www.rehateamprogeo.com

Data	Commessa	Utilizzatore	Indirizzo
------	----------	--------------	-----------

**O ROHO® MONOCOMPARTIMENT® Low Profile® altezza 5 cm** 370,00

Misure cuscino LxP	Adatto a seduta LSxPS	Codice	Misure cuscino LxP	Adatto a seduta LSxPS	Codice
<input type="checkbox"/> 30 x 30 - (6 x 6)	26,5+31 x 26,5+31	1R66LPC	<input type="checkbox"/> 42 x 42 - (9 x 9)	39,5+44 x 39,5+44	1R99LPC
<input type="checkbox"/> 30 x 33 - (6 x 7)	26,5+31 x 31+35	1R67LPC	<input type="checkbox"/> 42 x 46 - (9 x 10)	39,5+44 x 44+48,5	1R910LPC
<input type="checkbox"/> 33 x 33 - (7 x 7)	31+35 x 31+35	1R77LPC	<input type="checkbox"/> 42 x 51 - (9 x 11)	39,5+44 x 48,5+52,5	1R911LPC
<input type="checkbox"/> 33 x 38 - (7 x 8)	31+35 x 35+39,5	1R78LPC	<input type="checkbox"/> 46 x 38 - (10 x 8)	44+48,5 x 35+39,5	1R108LPC
<input type="checkbox"/> 33 x 42 - (7 x 9)	31+35 x 39,5+44	1R79LPC	<input type="checkbox"/> 46 x 42 - (10 x 9)	44+48,5 x 39,5+44	1R109LPC
<input type="checkbox"/> 38 x 33 - (8 x 7)	35+39,5 x 31+35	1R87LPC	<input type="checkbox"/> 46 x 46 - (10 x 10)	44+48,5 x 44+48,5	1R1010LPC
<input type="checkbox"/> 38 x 38 - (8 x 8)	35+39,5 x 35+39,5	1R88LPC	<input type="checkbox"/> 46 x 51 - (10 x 11)	44+48,5 x 48,5+52,5	1R1011LPC
<input type="checkbox"/> 38 x 42 - (8 x 9)	35+39,5 x 39,5+44	1R89LPC	<input type="checkbox"/> 51 x 42 - (11 x 9)	48,5+52,5 x 39,5+44	1R119LPC
<input type="checkbox"/> 38 x 46 - (8 x 10)	35+39,5 x 44+48,5	1R810LPC	<input type="checkbox"/> 51 x 46 - (11 x 10)	48,5+52,5 x 44+48,5	1R1110LPC
<input type="checkbox"/> 42 x 38 - (9 x 8)	39,5+44 x 35+39,5	1R98LPC	<input type="checkbox"/> 51 x 51 - (11 x 11)	48,5+52,5 x 48,5+52,5	1R1111LPC



**O ROHO® QUADTRO SELECT® High Profile® altezza 10 cm** 630,00

Misure cuscino LxP	Adatto a seduta LSxPS	Codice	Misure cuscino LxP	Adatto a seduta LSxPS	Codice
<input type="checkbox"/> 30 x 30 - (6 x 6)	26,5+31 x 26,5+31	QS66C	<input type="checkbox"/> 42 x 46 - (9 x 10)	39,5+44 x 44+48,5	QS910C
<input type="checkbox"/> 30 x 33 - (6 x 7)	26,5+31 x 31+35	QS67C	<input type="checkbox"/> 42 x 51 - (9 x 11)	39,5+44 x 48,5+52,5	QS911C
<input type="checkbox"/> 33 x 33 - (7 x 7)	31+35 x 31+35	QS77C	<input type="checkbox"/> 42 x 56 - (9 x 12)	39,5+44 x 52,5+57	QS912C
<input type="checkbox"/> 33 x 38 - (7 x 8)	31+35 x 35+39,5	QS78C	<input type="checkbox"/> 46 x 38 - (10 x 8)	44+48,5 x 35+39,5	QS108C
<input type="checkbox"/> 33 x 42 - (7 x 9)	31+35 x 39,5+44	QS79C	<input type="checkbox"/> 46 x 42 - (10 x 9)	44+48,5 x 39,5+44	QS109C
<input type="checkbox"/> 38 x 33 - (8 x 7)	35+39,5 x 31+35	QS87C	<input type="checkbox"/> 46 x 46 - (10 x 10)	44+48,5 x 44+48,5	QS1010C
<input type="checkbox"/> 38 x 38 - (8 x 8)	35+39,5 x 35+39,5	QS88C	<input type="checkbox"/> 46 x 51 - (10 x 11)	44+48,5 x 48,5+52,5	QS1011C
<input type="checkbox"/> 38 x 42 - (8 x 9)	35+39,5 x 39,5+44	QS89C	<input type="checkbox"/> 46 x 56 - (10 x 12)	44+48,5 x 52,5+57	QS1012C
<input type="checkbox"/> 38 x 46 - (8 x 10)	35+39,5 x 44+48,5	QS810C	<input type="checkbox"/> 51 x 42 - (11 x 9)	48,5+52,5 x 39,5+44	QS119C
<input type="checkbox"/> 42 x 38 - (9 x 8)	39,5+44 x 35+39,5	QS98C	<input type="checkbox"/> 51 x 46 - (11 x 10)	48,5+52,5 x 44+48,5	QS1110C
<input type="checkbox"/> 42 x 42 - (9 x 9)	39,5+44 x 39,5+44	QS99C	<input type="checkbox"/> 51 x 51 - (11 x 11)	48,5+52,5 x 48,5+52,5	QS1111C



**O ROHO® QUADTRO SELECT® Low Profile® altezza 5 cm** 630,00

Misure cuscino LxP	Adatto a seduta LSxPS	Codice	Misure cuscino LxP	Adatto a seduta LSxPS	Codice
<input type="checkbox"/> 28 x 30 - (5 x 6)	22+26,5 x 26,5+31	QS56LPC	<input type="checkbox"/> 42 x 42 - (9 x 9)	39,5+44 x 39,5+44	QS99LPC
<input type="checkbox"/> 30 x 30 - (6 x 6)	26,5+31 x 26,5+31	QS66LPC	<input type="checkbox"/> 42 x 46 - (9 x 10)	39,5+44 x 44+48,5	QS910LPC
<input type="checkbox"/> 30 x 33 - (6 x 7)	26,5+31 x 31+35	QS67LPC	<input type="checkbox"/> 42 x 51 - (9 x 11)	39,5+44 x 48,5+52,5	QS911LPC
<input type="checkbox"/> 33 x 33 - (7 x 7)	31+35 x 31+35	QS77LPC	<input type="checkbox"/> 46 x 38 - (10 x 8)	44+48,5 x 35+39,5	QS108LPC
<input type="checkbox"/> 33 x 38 - (7 x 8)	31+35 x 35+39,5	QS78LPC	<input type="checkbox"/> 46 x 42 - (10 x 9)	44+48,5 x 39,5+44	QS109LPC
<input type="checkbox"/> 33 x 42 - (7 x 9)	31+35 x 39,5+44	QS79LPC	<input type="checkbox"/> 46 x 46 - (10 x 10)	44+48,5 x 44+48,5	QS1010LPC
<input type="checkbox"/> 38 x 33 - (8 x 7)	35+39,5 x 31+35	QS87LPC	<input type="checkbox"/> 46 x 51 - (10 x 11)	44+48,5 x 48,5+52,5	QS1011LPC
<input type="checkbox"/> 38 x 38 - (8 x 8)	35+39,5 x 35+39,5	QS88LPC	<input type="checkbox"/> 51 x 42 - (11 x 9)	48,5+52,5 x 39,5+44	QS119LPC
<input type="checkbox"/> 38 x 42 - (8 x 9)	35+39,5 x 39,5+44	QS89LPC	<input type="checkbox"/> 51 x 46 - (11 x 10)	48,5+52,5 x 44+48,5	QS1110LPC
<input type="checkbox"/> 38 x 46 - (8 x 10)	35+39,5 x 44+48,5	QS810LPC	<input type="checkbox"/> 51 x 51 - (11 x 11)	48,5+52,5 x 48,5+52,5	QS1111LPC
<input type="checkbox"/> 42 x 38 - (9 x 8)	39,5+44 x 35+39,5	QS98LPC			



**O ROHO® CONTOUR SELECT®** 630,00

Misure cuscino LxP	Adatto a seduta LSxPS	Codice	Misure cuscino LxP	Adatto a seduta LSxPS	Codice
<input type="checkbox"/> 33 x 38 - (7 x 8)	31+35 x 35+39,5	CS78C	<input type="checkbox"/> 42 x 51 - (9 x 11)	39,5+44 x 48,5+52,5	CS911C
<input type="checkbox"/> 38 x 38 - (8 x 8)	35+39,5 x 35+39,5	CS88C	<input type="checkbox"/> 46 x 42 - (10 x 9)	44+48,5 x 39,5+44	CS109C
<input type="checkbox"/> 38 x 42 - (8 x 9)	35+39,5 x 39,5+44	CS89C	<input type="checkbox"/> 46 x 46 - (10 x 10)	44+48,5 x 44+48,5	CS1010C
<input type="checkbox"/> 38 x 46 - (8 x 10)	35+39,5 x 44+48,5	CS810C	<input type="checkbox"/> 46 x 51 - (10 x 11)	44+48,5 x 48,5+52,5	CS1011C
<input type="checkbox"/> 42 x 38 - (9 x 8)	39,5+44 x 35+39,5	CS98C	<input type="checkbox"/> 51 x 42 - (11 x 9)	48,5+52,5 x 39,5+44	CS119C
<input type="checkbox"/> 42 x 42 - (9 x 9)	39,5+44 x 39,5+44	CS99C	<input type="checkbox"/> 51 x 46 - (11 x 10)	48,5+52,5 x 44+48,5	CS1110C
<input type="checkbox"/> 42 x 46 - (9 x 10)	39,5+44 x 44+48,5	CS910C	<input type="checkbox"/> 51 x 51 - (11 x 11)	48,5+52,5 x 48,5+52,5	CS1111C



**O ROHO® ENHANCER®** 630,00

Misure cuscino LxP	Adatto a seduta LSxPS	Codice	Misure cuscino LxP	Adatto a seduta LSxPS	Codice
<input type="checkbox"/> 38 x 38 - (8 x 8)	35+39,5 x 35+39,5	ENH88C	<input type="checkbox"/> 46 x 42 - (10 x 9)	44+48,5 x 39,5+44	ENH109C
<input type="checkbox"/> 38 x 42 - (8 x 9)	35+39,5 x 39,5+44	ENH89C	<input type="checkbox"/> 46 x 46 - (10 x 10)	44+48,5 x 44+48,5	ENH1010C
<input type="checkbox"/> 42 x 38 - (9 x 8)	39,5+44 x 35+39,5	ENH98C	<input type="checkbox"/> 46 x 51 - (10 x 11)	44+48,5 x 48,5+52,5	ENH1011C
<input type="checkbox"/> 42 x 42 - (9 x 9)	39,5+44 x 39,5+44	ENH99C	<input type="checkbox"/> 51 x 46 - (11 x 10)	48,5+52,5 x 44+48,5	ENH1110C
<input type="checkbox"/> 42 x 46 - (9 x 10)	39,5+44 x 44+48,5	ENH910C			



Carrozina : Progeo JOKER R2 - Rev. 2026.0	Prezzo IVA esclusa da sommare al prezzo di listino	Pagina da inviare se sono stati scelti optional <input checked="" type="checkbox"/> standard (fornito in assenza di altre indicazioni) <input type="checkbox"/> su richiesta (senza aggiunta di prezzo) <input type="checkbox"/> optional (sommare il prezzo a quello di listino)
---	---	--

Stampato il

Permobil Progeo Active Design s.r.l. - a Socio Unico - Vicolo L. Negrelli, 5 - 31038 Paese (TV) - Tel. +39 0422 484657  
 P.IVA, Codice Fiscale e Numero di iscrizione al Registro Imprese di Treviso 10246110968 - Fatturatore Elettronico: Codice Destinatario A4707H7 - Capitale Sociale I.V. € 10.000,00

Email: info\_fi@permobil.com - web: http://www.rehateamprogeo.com

Permobil Progeo Active Design s.r.l. - a Socio Unico - Vico L. Negrilli, 5 - 31038 Paese (TV) - Tel. +39 0422 484657  
 P. IVA, Codice Fiscale e Numero di Iscrizione al Registro Imprese di Treviso 10246110969 - Fatturazione Elettronica: Codice Destinatario A4707H7 - Capitale Sociale I.V. € 10.000,00

Data	Commessa	Utilizzatore	Indirizzo
------	----------	--------------	-----------

Ruota 12" - Motore 250W (potenza massima 750W)  
 Ruota 14" - Motore 1000W (potenza massima 1500W)

- Display a colori con pulsantiera
- Limite di velocità massima impostabile da display
- 5 livelli di velocità selezionabili
- 10 livelli di accelerazione selezionabili da display
- Cruise control adattivo (mantiene velocità anche in discesa)
- Leva di comando freno a disco ed elettronico
- Freno motore (regolabile in 10 livelli da display)
- Freno elettronico a pulsante (regolabile in 10 livelli da display)
- Recupero energia in frenata
- Gestione messaggi di errore da display (con registro storico)
- Segnalatore acustico retromarcia
- Batteria 48V - 5,8Ah Autonomia fino a 25km
- Batteria potenziata 48V - 11,6Ah Autonomia fino a 50km
- Caricabatteria 48V
- Retromarcia
- Ingresso USB
- Cavalletto di stazionamento
- Parafango ruota
- Cupolino anteriore con predisposizione faro FULL LED

**(Software certificato)**

**○ Mototronic**

Codici di riconducibilità Nomenclatore Tariffario  
 Riconducibile N.T. Cod. 12.21.27.006 - Carrozina elettrica ad uso interno/esterno  
 oppure  
 Riconducibile N.T. Cod. 12.24.09.015 - Kit di motorizzazione universale per carrozzine

10979 **2.900,00**



**Manubrio**

☆ **Comandi STANDARD**

☆ Acceleratore a pollice

☆ Destra  
12592

□ Sinistra  
12593

○ Acceleratore a manopola

○ Destra  
10913

○ Sinistra  
10914

**40,00**

□ Leva di comando freno a disco ed elettronico

☆ Destra  
12594

□ Sinistra  
12595

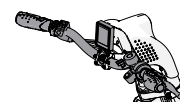

**○ Comandi per TETRAPLEGICI**

Manubrio PUSH&PULL

10905 **490,00**

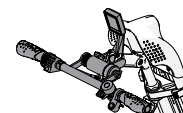

☆ **MOTOTRONIK Ruota 12"**

Motore 250W (potenza massima 750W)  
 Velocità massima secondo norma di legge

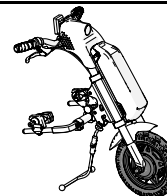

**○ MOTOTRONIK Ruota 14"**

Motore 1000W (potenza massima 1500W)  
 Velocità massima secondo norma di legge

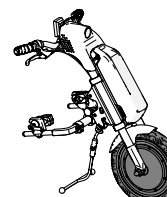

10903 **440,00**

**Batteria**

☆ Batteria 48V - 5,8Ah

*Autonomia fino a 25 km*





○ Batteria potenziata 48V - 11,6Ah

*Autonomia fino a 50 km*

10904 **330,00**

Data ..... Commessa ..... Utilizzatore ..... Indirizzo .....

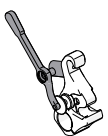
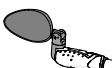
## Accessori

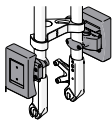
- |   |   |       |               |
|---|---|-------|---------------|
| <input type="checkbox"/> Faro FULL LED (alta intensità)<br>Incorporato sul cupolino   |    | 10908 |               |
| <input type="radio"/> Prolunga manubrio (avvicinamento guida)<br>Regolabile da 15cm fino a 23cm   |    | 10907 | <b>190,00</b> |
| <input type="radio"/> Leva sgancio facilitato gruppo motore<br>Consigliato con manubrio per tetraplegici  |    | 10915 | <b>80,00</b>  |
| <input type="radio"/> FLY Batteria aggiuntiva 48V - 2,9Ah<br>Autonomia fino a 15km<br>Omologata per trasporto aereo   |   | 10906 | <b>600,00</b> |
| <input type="radio"/> Specchietto retrovisore   |    | 10909 | <b>40,00</b>  |
|   | <input type="radio"/> Destro<br><input type="radio"/> Sinistro                        | 10909 | <b>40,00</b>  |
| <input type="radio"/> Cestino (removibile) - (con sistema di aggancio KCLICKfix®)   |   | 10912 | <b>200,00</b> |
| <input type="radio"/> Zavorra anteriore removibile - (con sistema di aggancio KCLICKfix®)<br>(Aumenta il peso della ruota motrice per migliorare la trazione) |  | 10910 | <b>300,00</b> |
| <input type="radio"/> Sacca da trasporto  |   | 10916 | <b>150,00</b> |

## Note

Permobili Progeo Active Design s.r.l. - a Socio Unico - Vico L. Negrilli, 5 - 31038 Paese (TV) - Tel. +39 0422 484657  
 P. IVA, Codice Fiscale e Numero di Iscrizione al Registro Imprese di Treviso 10246110968 - Fatturazione Elettronica: Codice Destinatario A4707H7 - Capitale Sociale L.V. € 10.000,00

Email: info\_it@permobili.com - web: http://www.rehateamprogeo.com

### Pagina da inviare se sono stati scelti optional

- |                                     |                     |   |
|-------------------------------------|---------------------|---|
| <input checked="" type="checkbox"/> | <b>standard</b>     | (fornito in assenza di altre indicazioni) |
| <input type="checkbox"/>            | <b>su richiesta</b> | (senza aggiunta di prezzo)                |
| <input type="radio"/>               | <b>optional</b>     | (sommare il prezzo a quello di listino)   |

Carrozzina : Progeo JOKER R2 - Rev. 2026.0

Prezzo IVA esclusa  
da sommare al prezzo di listino

Data ..... Commessa ..... Utilizzatore ..... Indirizzo .....

**SMARTDRIVE - compreso di caricabatteria**



<p><b>SWITCH CONTROL (DX+SX) - EU</b> Funzionamento a due pulsanti</p>	<input type="radio"/> 6 KM/H	MX2-S002	4.000,00
	<input type="radio"/> 9 KM/H	MX2-S005	4.100,00
<p><b>SWITCH CONTROL + JACK 3.5 - EU</b> Un pulsante e un ingresso femmina Mono che permette di collegare SmartDrive con un qualsiasi altro dispositivo di comando/guida.</p>	<input type="radio"/> 6 KM/H	MX2-S003	4.000,00
	<input type="radio"/> 9 KM/H	MX2-S006	4.100,00

**Pulsante di comando esterno BUDDY BUTTON**  
completo di adattatore, set di montaggio e braccio di estensione  
*Disponibile solo con SWITCH CONTROL + JACK 3.5*



MX2-BBB 250,00

**KIT FISSAGGIO TELAIO RIGIDO**

Scegliere kit di fissaggio in funzione della misura delle ruote posteriori della carrozzina

- kit fissaggio telaio rigido - ruote posteriori 22" - 24" MX2-44S-C
- kit fissaggio telaio rigido - ruote posteriori 25" MX2-45S-C
- kit fissaggio telaio rigido - ruote posteriori 26" MX2-46S-C

**SMART WATCH**

Lo SmartDrive può essere comandato e gestito con uno Smart Watch APPLE o GALAXY  
Configurazione semplice e veloce  
Maggiore visibilità dello schermo  
Prestazioni della batteria migliorate  
App gratuita su Apple Store e Play Store

**Lista compatibilita'**



**Smart Watch compatibili**

**APPLE WATCH**  
serie 5 o successivi con iOS 8 o successivi  
Apple iPhone

**GALAXY WATCH**  
serie 4 o successivi  
Smartphone Samsung  
Smartphone Android 6.0 e RAM almeno 1.5 GB

**Applicazioni gratuite**

SmartDrive MX2+



Pushtracker



**Accessori**

Borsa da trasporto



MX2SD-BAG 60,00

Maniglia universale imbottita  
*Maniglia universale imbottita*



MX2-986 20,00

Carrozzina : Progeo JOKER R2 - Rev. 2026.0

Prezzo IVA esclusa  
da sommare al prezzo di listino

**Pagina da inviare se sono stati scelti optional**

- standard** (fornito in assenza di altre indicazioni)
- su richiesta** (senza aggiunta di prezzo)
- optional** (sommare il prezzo a quello di listino)

Permobili Progeo Active Design s.r.l. - a Socio Unico - Vicolo L. Negrilli, 5 - 31038 Paese (TV) - Tel. +39 0422 484657  
 P.IVA, Codice Fiscale e Numero di iscrizione al Registro Imprese di Treviso 10246110968 - Fatturazione Elettronica: Codice Destinatario A4707H7 - Capitale Sociale I.V. € 10.000,00

Email: info\_it@permobil.com - web: http://www.relateamprogeo.com