

Rigid frame wheelchair

Date

User name

Company stamp

Responsible

Carbon fibre frame

Wheelchair measures

Seat width (LS) 33 36 39 42 45 48

The seat width is measured from the outer sides of the frame, while the distance between the two side guards is 1 cm wider.

Seat depth (PS) 35 37,5 40 42,5 45 47,5 50

The real seat depth, from the front part of the seat cloth to the backrest tube will be 1,5 cm more than the declared one.

Footplate distance (DP) **(Real distance between seat and footplate)**

IMPORTANT NOTICE! From the footplate to the floor minimum 4cm.!! (Minimum Front height = DP + 4cm.)

Setting ☆ Standard Prudential Active Extreme

Backrest Height (TS) Std.Value 33,5 (min 24.5-max 47)

camber ☆ 0° 2° 4°

Front height STD 49 Rear height STD 42
24" Rear wheel (min 38-max 46)
25" Rear wheel (min 39-max 47)
26" Rear wheel (min 40-max 48)

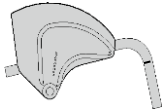

☆ Version mudguard (Available only with rear wheels 24")

Version straight sideguard

Seat

☆ Seat cloth with pocket (under seat)

Seat with tension straps

08883

£ 196

Carbon rigid seat

08336

£ 415

Pocket (under seat) [25x11x4,5]

08281

£ 65

STYLE

☆ CARBON Essence

ALA ROSSA

07947

£ 109

ALA BIANCA

07948

£ 109

Footplate

☆ Carbon fibre footplate - adjustable distance +/- 1,5cm. SPECIAL FLIP-UP!

Minimum footplate distance 35cm.

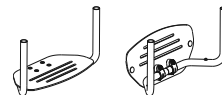

Date Order English User name Address

Backrest with rake adjustable from -4° to +16°

- Backrest with double locking (upright and folded)
- Backrest with upright locking system ONLY (no locking when folded)
- Fixed back(non-folding back)

☆ Aluminium backrest

Titanium backrest

Carbon fibre backrest



06811 £ 164

(Lightest configuration)

04389 £ 655

A I R - Integrated posture backrest (not removable) - Lateral retaining 6,5cm. 06815 £ 1015
not available for seat width 48 - Std. Backrest upholstery not provided - Handle tube aluminium with short tubes

Lateral retaining wing B=low

Carbon shell H25

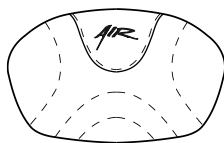

Backrest Height (TS) min 29 max 41

Carbon shell H33

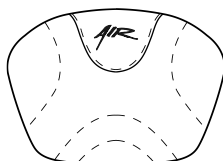

Backrest Height (TS) (37 + 46)

Lateral retaining wing A=high

Carbon shell H30

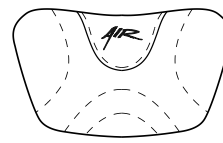

Backrest Height (TS) (32 + 42,5)

AIR Cover

☆ Cover Standard - fabric insert: GREY, stitchings GREY

Cover SPORT

09195 £ 87

- fabric insert: BLACK - Stitchings GREY
- fabric insert: BLACK - Stitchings LIME
- fabric insert: BLACK - Stitchings ORANGE
- fabric insert: BLACK - Stitchings RED
- fabric insert: BLACK - Stitchings BLUE
- fabric insert: BLACK - Stitchings BLACK
- fabric insert: BLACK - Stitchings FUCHSIA
- fabric insert: BLACK - Stitchings ANTHRACITE

Cover ACTIVE

09195 £ 87

- fabric insert: RED - Stitchings BLACK
- fabric insert: LIME - Stitchings BLACK
- fabric insert: BLUE - Stitchings BLACK

fabric insert:

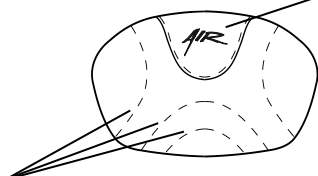

Transpiring fabric stitchings

Handle tube

☆ Handle tube STD

- Handle tube with short tubes
- Handle tube SPORT Without push handles

Carbon fibre handle (with short tubes)

(Lightest configuration)

04390 £ 131

Not available with: Posture backrest PHYSIO - Posture backrest A I R

Folding handles aluminium



02958 £ 218

Casters

☆ 4" Soft

3" Sport

(Lightest configuration)

5" Soft

3" Active Soft (wide)

(Aluminium alloy rim)

06824 £ 109

4" Active Sport (narrow)

(Aluminium alloy rim)

01398 £ 109

4" Active Soft (wide)

(Aluminium alloy rim)

03943 £ 109

5" Active Soft (wide)

(Aluminium alloy rim)

07518 £ 109

English

Date Order User name Address

Rear wheels

Available with : VERSION MUDGUARD - VERSION STRAIGHT SIDEGUARD

☆ 24" Ultra-light Progeo - Standard!

<input type="radio"/> 24" ULTRA-LIGHT PROGEO KEY SPORT	(Lightest configuration)	04383	£ 764
<input type="radio"/> 24" Ultra-light "Spinergy LX"		01685	£ 764
<input type="radio"/> 24" Ultra-light "Spinergy Flex rim"		02270	£ 1200
<input type="radio"/> 24" Ultra-light "Spinergy LXL"	<input type="checkbox"/> Black hub and white blade spokes <input type="checkbox"/> Hub and blade spokes black	07846	£ 764
<input type="radio"/> 24" Off-road (aluminium handrim black)		01392	£ 196

Available only with: VERSION STRAIGHT SIDEGUARD

<input type="checkbox"/> 22" Ultra-light Progeo - Standard!			
<input type="checkbox"/> 25" Ultra-light Progeo - Standard!	(colour: black)		
<input type="checkbox"/> 26" Progeo - Standard!	(colour: black)		
<input type="radio"/> 25" Ultra-light "Spinergy LX"		02101	£ 764
<input type="radio"/> 25" Ultra-light "Spinergy LXL"	<input type="checkbox"/> Black hub and white blade spokes	07847	£ 764
<input type="radio"/> 26" Ultra-light "Spinergy LX"		02102	£ 764

Rear wheel tyre







☆ High pressure tyre	(22"-24"-25"-26")	(Lightest configuration)		
<input type="checkbox"/> High pressure profile tyre	(24")			
<input type="radio"/> Marathon Plus	(24"-25")	with anti-puncture protection	01669	£ 55
<input type="radio"/> Solid tyre Kik Mako - Colour Black	(24")		01041	£ 109
<input type="radio"/> Solid tyre Kik Mako - Colour Grey	(24")		01751	£ 109

Handrim - Wheel distance

☆ 3 cm 4 cm

☆ Aluminium	(22"-24"-25"-26")	(Lightest configuration)		
<input type="radio"/> Aluminium black SOFT-TOUCH	(24"-25")		09170	£ 109
<input type="radio"/> Chromed Steel	(24"-25")		01684	£ 131
<input type="radio"/> Titanium	(24"-25")		00016	£ 240
<input type="radio"/> Ultra Grepp	(24"-25")		00017	£ 273
<input type="radio"/> Max Grepp	(24"-25")		00834	£ 305
<input type="radio"/> Ergo Para	(24")		00632	£ 305
<input type="radio"/> SURGE LT	(24"-25")	Oval countour with a rubber insert	06427	£ 316
<input type="radio"/> Quad (24")	(24")		00693	£ 175
<input type="radio"/> Silicon cover for standard aluminium handrim		Available for measures (22"-24"-25"-26")	04050	£ 142

Wheel locks

☆ Without brake	(Lightest configuration)		
<input type="checkbox"/> Bent lever push to lock			
<input type="checkbox"/> Straight lever Push to lock			
<input type="checkbox"/> Straight lever Pull to lock			
<input type="radio"/> Sport brake			06428 £ 109
<input type="radio"/> Brake with extension lever push to lock			01949 £ 55
<input type="radio"/> Brake with extension lever pull to lock			03372 £ 55

Armrests

<input type="radio"/> Swing away armrests	(Swing away, removable and height adjustable armrest)		00694 £ 218
	☆ Pad STANDARD		
	<input type="radio"/> Ergonomic pad (30x6 cm.)		04104 £ 55

Accessories



<input type="radio"/> Pad for front frame protectors		07058 £ 44
<input type="radio"/> Removable storage bag (with quick coupling)		09811 £ 109

Rehateam s.r.l. - Vicolo Negrelli, 5 - 31040 Castagnole di Paese (TV) - Tel. +39.0422.484657 / +39.0422.484661 / +39.0422.484684 - Fax +39.0422.480387 - P.IVA IT 03182520266 - C.C.I.A.A. TV n.225867 - Iscr. Trib. TV n.41690 Capitale Sociale I.V. Euro 100.000,00

Email: info@rehateamprogeo.com - web: http://www.rehateamprogeo.com

Date	Order	English User name	Address
------------	-------------	----------------------------	---------------

Optional 1

<input type="radio"/> Transit wheels			03290	£ 131
<input type="radio"/> Anti-tipper with rapid hookup	(inside rotation to reduce the encumbrance)			
	<input type="radio"/> Right		06821	£ 109
	<input type="radio"/> Left		06822	£ 109

Optional 2

<input type="radio"/> Lumbar support	(to insert in the backrest upholstery)		00013	£ 33
<input type="radio"/> Tetracclip	(Quick release axle for quadriplegic)		03947	£ 153

Additional Kit

<input type="radio"/> 24" Off-road rear wheels	Off-Road tyre - aluminium handrim (black colour)		03378	£ 436
<input type="radio"/> 24" FAT rear wheels	FAT tyre 3" - aluminium handrim (black colour)		09357	£ 764

PHYSIO - Posture backrest Std. Backrest upholstery not provided

<input type="radio"/> Aluminum shell - Lateral retaining STANDARD 7,5cm	Height <input type="checkbox"/> 25 <input type="checkbox"/> 33 <input type="checkbox"/> 41 Height <input type="checkbox"/> 52		05308	£ 884
			05309	£ 938
		Lateral retaining wing <input type="checkbox"/> A=high <input type="checkbox"/> B=low		
<input type="radio"/> Aluminum shell - Lateral retaining DEEP 15cm	Height <input type="checkbox"/> 25 <input type="checkbox"/> 33 <input type="checkbox"/> 41 Height <input type="checkbox"/> 52		05310	£ 938
		H25 not available for seat width 39-42-45-48		
		Lateral retaining wing <input type="checkbox"/> A=high <input type="checkbox"/> B=low	05311	£ 993
<input type="radio"/> Carbon shell - Lateral retaining STANDARD 7,5cm	Height <input type="checkbox"/> 25 <input type="checkbox"/> 33 <input type="checkbox"/> 41		05312	£ 1015
		Lateral retaining wing <input type="checkbox"/> A=high <input type="checkbox"/> B=low		

COVER

☆ Cover with fabric-cover of backrest's rear side and high refraction fabric hems



SWING AWAY - Lateral support
Not available with Physio backrest with lateral retaining DEEP and in carbon backrest

Internal thoracic support to the backrest width, adjustable (0 ÷ -1,5cm)

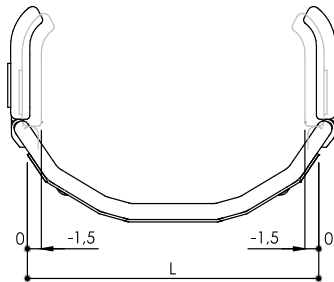

- | | |
|--|-------|
| Large (17,5x11,5) | |
| <input type="checkbox"/> Left | 05646 |
| <input type="checkbox"/> Right | 05647 |
| Small (14x9,5) | |
| <input type="checkbox"/> Left | 05642 |
| <input type="checkbox"/> Right | 05643 |
| <input type="checkbox"/> Additional Kit for internal thoracic support to the backrest width, adjustable (-8,5 ÷ -10cm) | |

Internal thoracic support to the backrest width, adjustable (-4 ÷ -5,5cm)

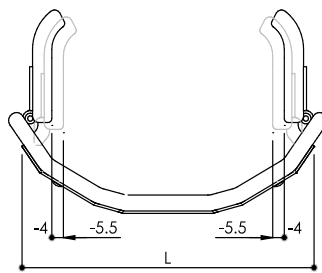

- | | |
|--------------------------------|-------|
| Large (17,5x11,5) | |
| <input type="checkbox"/> Left | 05646 |
| <input type="checkbox"/> Right | 05647 |
| Small (14x9,5) | |
| <input type="checkbox"/> Left | 05642 |
| <input type="checkbox"/> Right | 05643 |

Internal thoracic support to the backrest width, adjustable (-8,5 ÷ -10cm)

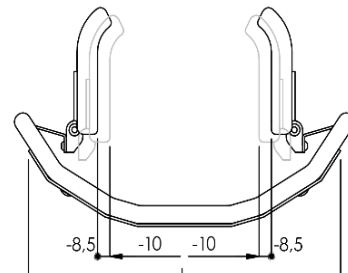

- | | | |
|--|-------|-------|
| Large (17,5x11,5) | | |
| <input type="checkbox"/> Left | 05646 | £ 175 |
| <input type="checkbox"/> Right | 05647 | £ 175 |
| Small (14x9,5) | | |
| <input type="checkbox"/> Left | 05642 | £ 175 |
| <input type="checkbox"/> Right | 05643 | £ 175 |
| <input type="checkbox"/> (with additional kit) | | |

Headrest adjustable - Double ball mounting system
Not available for Physio backrest's height 25 and with carbon shell

<input type="checkbox"/> Large (34x14)			05648	£ 393
<input type="checkbox"/> Small (28x14)				

Rehateam s.r.l. Vicolo Negrelli, 5 - 31040 Castagnole di Paese (TV) - Tel. +39.0422.484657 / +39.0422.480387 - Fax +39.0422.484661 / +39.0422.484684
P.IVA IT 03182520266 - C.C.I.A.A. TV n. 225867 - Iscr. Trib. TV n. 41690 Capitale Sociale I.V. Euro 100.000,00

Email: info@rehateamprogeo.com - web: http://www.rehateamprogeo.com

English

Date Order User name Address

Rehateam s.r.l. Vicolo Negrelli, 5 - 31040 Castagnole di Paese (TV) - Tel. +39.0422.484657 / +39.0422.480387 - Fax +39.0422.484661 / +39.0422.484684
 P. IVA IT 03182520266 - C.C.I.A.A. TV n.225867 - Iscr.Trib. TV n.41690 Capitale Sociale I.V. Euro 100.000,00

Email: info@rehateamprogeo.com - web: http://www.rehateamprogeo.com

REFERENCE TABLES

1	Rear wheels	
	Model	Features
	24" Ultra-light Progeo - Standard!	(available for all colours)
	24" ULTRA-LIGHT PROGEO KEY SPORT	(silver hub, black rim and 16 spokes)
	24" Ultra-light "Spinergy LX"	(silver hub, black rim and spokes)
	24" Ultra-light "Spinergy LXL"	(black hub and rim, 18 white blade spokes) - (black hub, rim and 18 spokes)
	24" Ultra-light "Spinergy Flex rim"	(silver hub, black rim and spokes) - (integrated aluminium/rubber handrim - encumbrance reduction up to 3cm. - all tyre)
	24" Off-road	(colour: black) - (aluminium handrim - tyre Off-road)

Italia Certified company normative UNI EN ISO 9001

Important notices page only if any optional have been chosen

Pag. 5 / 5	Wheelchair : CARBOMAX - Rev. 2020.0	Prices in EURO - VAT excluded to be added to the price list	<input checked="" type="checkbox"/> standard (supplied if no requests are indicated) <input type="checkbox"/> on request (without extra charge) <input type="checkbox"/> optional (cost to be added at the basic price)
------------	-------------------------------------	--	--