

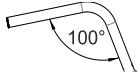
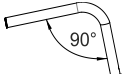
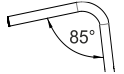

Date User End user weight (kg) Language user manual	Progeo (English) Company stamp Responsible	Folding frame wheelchair
--------------------------------------------------------------------------------------	-------------------------------------------------------------------	---------------------------------

Wheelchair measures - The tolerance on all the dimensions indicated and/or required is ± 10 mm						
Seat width (LS)	<input type="checkbox"/> 33	<input type="checkbox"/> 36	<input type="checkbox"/> 39	<input type="checkbox"/> 42	<input type="checkbox"/> 45	<input type="checkbox"/> 48
<small>The seat width is measured from the outer sides of the frame, while the distance between the two side guards is 1 cm wider. For seat enlargement see section enlargement of mudguard and armrest with integrated mudguard</small>						
Seat depth (PS)	<input type="checkbox"/> 35	<input type="checkbox"/> 37,5	<input type="checkbox"/> 40	<input type="checkbox"/> 42,5	<input type="checkbox"/> 45	<input type="checkbox"/> 47,5
<small>The real seat depth, from the front part of the seat cloth to the backrest tube will be 1,5 cm more than the declared one.</small>						
Footplate distance (DP) (cm) ±0.5cm - adjustment steps 1.5cm (Real distance between seat and footplate) - IMPORTANT NOTICE! From the footplate to the floor minimum 4cm !! (Minimum Front height = DP + 4cm)					
Setting	<input checked="" type="checkbox"/> Standard		<input type="checkbox"/> Prudential		<input type="checkbox"/> Active	
Backrest Height (TS)	Std. Value 33,5(min 26-max 47) adjustment steps 1.5cm					
camber	<input checked="" type="checkbox"/> 0°		<input type="checkbox"/> 2°			
Front height STD 49					
Rear height STD 42					

Front frame		
<input checked="" type="checkbox"/> Aluminium standard frame		
 <input checked="" type="checkbox"/>	 <input type="checkbox"/> (max 5" caster)	 <input type="checkbox"/> (max 4" caster)

Frame colour			
Frame colour (without extra charge)			
<input checked="" type="checkbox"/> Opaque black	<input type="checkbox"/> POLAR white	<input type="checkbox"/> Matt orange	
<input type="checkbox"/> Tekno anthracite	<input type="checkbox"/> Matt Midnight blue	<input type="checkbox"/> Matt grey	<input type="checkbox"/> Matt red
Frame colour on request			
<input type="checkbox"/> Bright silver	<input type="checkbox"/> Bright fuchsia	<input type="checkbox"/> Bright blue china	12579
<input type="checkbox"/> Bright blue	<input type="checkbox"/> Bright lime	<input type="checkbox"/> Bright red	

Backrest
<input checked="" type="checkbox"/> Adjustable velcro straps and padded transpiring upholstery

Handle tube	
<input checked="" type="checkbox"/> Tubes with short handle	
<input type="checkbox"/> Tubes with standard handle	
<input type="checkbox"/> SPORT tubes Without push handles	<i>Lightest configuration</i>
<input type="checkbox"/> Folding handles	 02958
<small>Not available with: Push handles for companion</small>	

Casters		
<input checked="" type="checkbox"/> 4" Soft		
<input type="checkbox"/> 3" Sport	<i>Lightest configuration</i>	
<input type="checkbox"/> 5" Soft		
<input type="checkbox"/> 6" Soft	<small>(Available only with 100° angle)</small>	
<input type="checkbox"/> 6" Pneumatic	<small>(Available only with 100° angle)</small>	
<input type="checkbox"/> 3" Active Soft (wide)	<small>(Aluminium alloy rim)</small>	06824
<input type="checkbox"/> 4" Active Sport (narrow)	<small>(Aluminium alloy rim)</small>	01398
<input type="checkbox"/> 4" Active Soft (wide)	<small>(Aluminium alloy rim)</small>	03943
<input type="checkbox"/> 5" Active Soft (wide)	<small>(Aluminium alloy rim)</small>	07518
<input type="checkbox"/> 5" Pneumatic		10844

Support front fork	
<input checked="" type="checkbox"/> Standard support front fork	
<input type="checkbox"/> Front fork support V Design 2.0	
<small>Exclude the installation of : Quick release front forks</small>	

Date	Order	User	Address
------------	-------------	------------	---------------

Special Options	
<input type="checkbox"/> Rear wheels plate extension	01950
<input type="checkbox"/> lockingband/strip to close/fold the wheelchair	06833
<input type="checkbox"/> Drawstring to unlock the back with a singleaction	06834

Colour set: includes rear wheel hub and rim and front forks	
Only standard Progeo 22"/24" wheels have coloured hubs and rims	
☆ Black	22" 24" 25" 26" 00833
<input type="checkbox"/> Bright silver	22" 24" 00833
<input type="checkbox"/> Bright lime	22" 24" 00833
<input type="checkbox"/> Bright blue	22" 24" 00833
<input type="checkbox"/> Bright red	22" 24" 00833
<input type="checkbox"/> Bright fuchsia	22" 24" 00833
<input type="checkbox"/> POLAR white	22" 24" 00833
<input type="checkbox"/> Tekno anthracite	22" 24" 00833
<input type="checkbox"/> Matt Midnight blue	22" 24" 00833
<input type="checkbox"/> Matt grey	22" 24" 00833
<input type="checkbox"/> Matt red	22" 24" 00833

Rear wheels	
☆ 24" Ultra-light Progeo - Standard!	
<input type="checkbox"/> 22" Ultra-light Progeo - Standard!	
<input type="checkbox"/> 25" Ultra-light Progeo - Standard!	(colour: black)
<input type="checkbox"/> 26" Progeo - Standard!	(colour: black)
<input type="checkbox"/> 24" ULTRA-LIGHT PROGEO KEY SPORT	<i>Lightest configuration</i>
<input type="checkbox"/> 24" Ultra-light "Spinergy LX"	
<input type="checkbox"/> 24" Ultra-light "Spinergy LXL"	<input type="checkbox"/> Black hub and white spokes <input type="checkbox"/> Hub and spokes black
<input type="checkbox"/> 24" Ultra-light "Spinergy Flex rim"	Integrated aluminium/rubber handrim
<input type="checkbox"/> 25" Ultra-light "Spinergy LX"	
<input type="checkbox"/> 25" Ultra-light "Spinergy LXL"	<input type="checkbox"/> Black hub and white spokes
<input type="checkbox"/> 26" Ultra-light "Spinergy LX"	
<input type="checkbox"/> 24" Off-road (aluminium handrim black - Wheel distance 4cm)	

Rear wheel tyre	
☆ High pressure tyre	(22"-24"-25"-26") <i>Lightest configuration</i>
<input type="checkbox"/> High pressure profile tyre	(24")
<input type="checkbox"/> Marathon Plus	(24"-25") with anti-puncture protection
<input type="checkbox"/> Anti-puncture - Colour Black	(24") 01669
Not available with Rear wheels : 24" ULTRA-LIGHT PROGEO KEY SPORT, 24" Ultra-light "Spinergy LXL"	
<input type="checkbox"/> Anti-puncture - Colour Grey	(22") 011083
<input type="checkbox"/> Anti-puncture - Colour Grey	(22") 04181

Handrim	Wheel distance	☆ 3 cm	<input type="checkbox"/> 4 cm	
☆ Aluminium	(22"-24"-25"-26")			<i>Lightest configuration</i>
<input type="checkbox"/> Aluminium black SOFT-TOUCH	(24"-25")			(24" handrim, on 25" wheel is installed with spacers) 09170
<input type="checkbox"/> Chromed Steel	(24"-25")			(24" handrim, on 25" wheel is installed with spacers) 01684
<input type="checkbox"/> Titanium	(24"-25")			(24" handrim, on 25" wheel is installed with spacers) 00016
<input type="checkbox"/> Ultra Grepp	(24"-25")			(24" handrim, on 25" wheel is installed with spacers) 00017
<input type="checkbox"/> TOP FRICTION	(24"-25")			(24" handrim, on 25" wheel is installed with spacers) 11023
Oval countour with a rubber insert				
<input type="checkbox"/> NOVA H	(24"-25")			(24" handrim, on 25" wheel is installed with spacers) 11025
Ergonomic black profile				
<input type="checkbox"/> NOVA D	(24"-25")			(24" handrim, on 25" wheel is installed with spacers) 11026
Ergonomic profile with rubber coating (ideal for quadriplegics)				
<input type="checkbox"/> Silicon cover for standard aluminium handrim				Available for measures (22"- 24" - 26") 04050

Wheel locks	
☆ Bent lever push to lock	
<input type="checkbox"/> Straight lever push to lock	
<input type="checkbox"/> Straight lever pull to lock	
<input type="checkbox"/> Sport brake	<i>Lightest configuration</i>
<input type="checkbox"/> Brake with extension lever push to lock	
<input type="checkbox"/> Brake with extension lever pull to lock	



Date Order User Address

Automatic Closure footplate

☆ Footplate COMPACT, automatic Closure *Lightest configuration*  11529

Minimum footplate distance 35cm. **RAKE AND DEPTH ADJUSTABLE**

Internal External

Footplate - See reference tables N°3

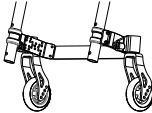
Warning!! All flip-up footrests, need a stretch calf band and standard fork-support 

Weight increase approx. 500gr.

Plastic footrest. rake adjustable *☆ 2/3 Internal* 2/3 External  11525

Minimum footplate distance 35cm.

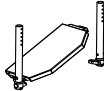
One piece footplate - Flip-up!. rake and depth adjustable Internal *☆ 2/3 Internal* External  11527

Minimum footplate distance 35cm.

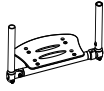
One piece aluminium footplate - Flip-up!. rake and depth adjustable Internal *☆ 2/3 Internal* 2/3 External  11528

Minimum footplate distance 35cm.

One piece Carbon fibre footplate, rake adjustable, swing away, flip-up. *☆ Internal* External  03291

Minimum footplate distance 35cm.

Mudguard

Mudguard - FIXED

☆ Carbon fibre mudguard
 Carbon fibre Straight sideguard

Mudguard enlargement
☆ + 0 cm
 + 1 cm + 2 cm

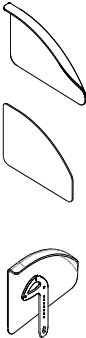
Extra charge for : REMOVABLE VERSION
NO → Mudguard enlargement  12648

 08921

Armrests

Tubular armrests (Swing away, removable and height adjustable armrest)  00694

Removable armrest with integrated mudguard

Desk armrests PROGEO (Removable and height adjustable)  09956

Enlargement of Desk armrests PROGEO
☆ + 0 cm
 + 2 cm Available only with Ultra-light Progeo standard wheels and camber 0° 12648

Removable armrest with carbon-fiber straight sideguard  09079

Accessories





Pad for front frame protectors 07058

Backrest-seat connection cloth 10241



Removable storage bag (with quick coupling) 09811

Date Order User Address

Optional 1

<input type="checkbox"/> Transit wheels			00836
<input type="checkbox"/> Anti-tipper with rapid hookup	(inside rotation to reduce the encumbrance) <input type="checkbox"/> Right <input type="checkbox"/> Left		00023 00024
<input type="checkbox"/> Tipping aid	<input type="checkbox"/> Right <input type="checkbox"/> Left		00025 01046
<input type="checkbox"/> Crutches support	<input type="checkbox"/> Right <input type="checkbox"/> Left		00838 00837

Optional 2

<input type="checkbox"/> Tetraclip	(Quick release axle for quadriplegic)		03947
<input type="checkbox"/> Safety pelvic belt			03972
<input type="checkbox"/> Harness			04103
<input type="checkbox"/> Quick release front forks	Available with: Standard support front fork		00030
<input type="checkbox"/> Push handles for companion	(Removable and height adjustable)		01048
<input type="checkbox"/> Lumbar support	(to insert in the backrest upholstery)		00013
<input type="checkbox"/> Swing away lateral support Prevents backrest folding	Not available with Posture backrest PHYSIO <input type="checkbox"/> Right <input type="checkbox"/> Left		02097 02098
<input type="checkbox"/> Spoke guards Black	(22"-24")		01043
<input type="checkbox"/> Spoke guards Transparent	(22"-24")		00835
<input type="checkbox"/> Spoke guards Progeo design	(22"-24")		00019

Additional Kit





<input type="checkbox"/> 24" Off-road rear wheels	Off-Road tyre - aluminium handrim (black colour)	03378
<input type="checkbox"/> 24" FAT rear wheels	FAT tyre 3" - aluminium handrim (black colour)	09357

Date Order User Address



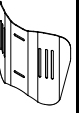
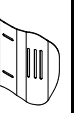

PHYSIO - Posture backrest
(Std. Backrest upholstery not provided)

Removable with quick release
Suitable for tubes with diameter 18+26mm
Depth adjustment (4cm)
Angle adjustment (±18°)

AIR Carbon shell
not available for seat width 48

BACKREST HEIGHT	28	34	40			
Shell's shape 	Lateral retaining wing A=high - R=regular					
	A	R	A	R	A	R
						
	<input type="checkbox"/>	<input type="checkbox"/>	<input type="checkbox"/>	<input type="checkbox"/>	<input type="checkbox"/>	<input type="checkbox"/>

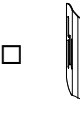
POSTURE Aluminum shell

BACKREST HEIGHT	34	40	52
Shell's shape 	Lateral retaining wing R=regular		
	R	R	R
			
	<input type="checkbox"/>	<input type="checkbox"/>	<input type="checkbox"/>

Configuration DEEP with side support PAD (height adjustable)

Alluminum lateral with padded, breathable upholstery.



Small (h 13cm)



Right 10272

Left 10272

Large (h 20cm)



Right 10273

Left 10273

SWING AWAY - Lateral support

Fixing and adjustment hardware complete with protection sleeve
Alluminum lateral with padded, breathable upholstery.

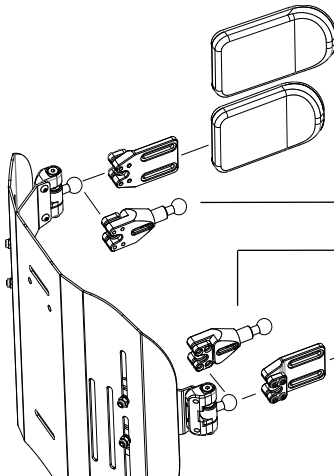

Large (18x12)

05647

Small (14x9)

05643

Lateral support extension

Quantity (number pcs).....
10271

Lateral support extension

Quantity (number pcs).....

Small (14x9)

05642

Large (18x12)

05646

Headrest adjustable - Double ball mounting system

Available only with backrest Physio Posture



Large (35x12,5)

05648



Small (25x12,5)

Date	Order	User	Address
------------	-------------	------------	---------------

Note

Wheelchair : Progeo EGO - Rev. 2026.0	Prices - VAT excluded to be added to the price list	<table border="1" style="width:100%; border-collapse: collapse;"> <tr> <td colspan="2" style="text-align: center; padding: 2px;">Send this page only if any optional have been chosen</td> </tr> <tr> <td style="width:10%; text-align: center; padding: 2px;">☆</td> <td style="padding: 2px;">standard (supplied if no requests are indicated)</td> </tr> <tr> <td style="text-align: center; padding: 2px;">□</td> <td style="padding: 2px;">on request (without extra charge)</td> </tr> <tr> <td style="text-align: center; padding: 2px;">○</td> <td style="padding: 2px;">optional (cost to be added at the basic price)</td> </tr> </table>	Send this page only if any optional have been chosen		☆	standard (supplied if no requests are indicated)	□	on request (without extra charge)	○	optional (cost to be added at the basic price)
Send this page only if any optional have been chosen										
☆	standard (supplied if no requests are indicated)									
□	on request (without extra charge)									
○	optional (cost to be added at the basic price)									

REFERENCE TABLES

1		Front height			
With closed frame (95°) max 5" caster With closed frame (90°) max 5" caster With closed frame (85°) max 4" caster					
FORK		Casters			
		3"	4"	5"	6"
SMALL 		max 46	max 47	max 48	
MEDIUM 		max 50	max 51	max 52	max 54
The size of the fork will be defined only by Progeo in accordance with wheelchair final configuration.					

2		Rear height			
Rear wheels					
		22"	24"	25"	26"
min 35		min 38	min 39	min 40	
max 43		max 45	max 46	max 48	

3	Footplate option	Footplate distance
	Footplate COMPACT, automatic Closure	min 36
	Plastic footrest	min 36
	One piece footplate - Flip-up!	min 36
	One piece aluminium footplate - Flip-up!	min 36
	One piece Carbon fibre footplate	min 36
IMPORTANT NOTICE! From the footplate to the floor minimum 4cm !! (Minimum Front height = DP + 4cm)		
NOTE! Lower footplate distances are possible only after our valuation		
Calculated with the best configuration and with the footplates positioned on inside.		

4	Rear wheels	
	Model	Features
	22" Ultra-light Progeo - Standard!	(not available in anthracite color)
	24" Ultra-light Progeo - Standard!	(available for all coulores)
	24" ULTRA-LIGHT PROGEO KEY SPORT	(silver hub, black rim and 16 spokes)
	24" Ultra-light "Spinergy LX"	(silver hub, black rim and spokes)
	24" Ultra-light "Spinergy LXL"	(black hub and rim, 18 white spokes) - (black hub, rim and 18 spokes)
	24" Ultra-light "Spinergy Flex rim"	(silver hub, black rim and spokes) - (integrated aluminium/rubber handrim - encumbrance reduction up to 3cm. - all tyre)
	24" Off-road	(colour: black) - (aluminium handrim - tyre Off-road)
	25" Ultra-light "Spinergy LX"	(silver hub, black rim and spokes)
	25" Ultra-light "Spinergy LXL"	(black hub and rim, 18 white spokes)
	26" Progeo - Standard!	(colour: black)
	26" Ultra-light "Spinergy LX"	(silver hub, black rim and 18 spokes)

Date	Order	User	Address
------	-------	------	---------

12" wheel - Motor 250W (750W maximum power)
14" wheel - Motor 1000W (1500W maximum power)

- Color display with switcher
- Maximum speed limit settable from display
- 5 speed levels selectable
- 10 display-selectable acceleration levels
- Adaptive Cruise Control
- Disc and electronic brake control lever
- Motor brake (adjustable in 10 levels from the display)
- Electronic brake with control bottom (adjustable in 10 levels from the display)
- Power regain when braking
- Error messages management from display (with error history)
- Rear gear beeper
- 48V - 5.8 Ah battery Autonomy up to 25km
- 48V - 11.6 Ah Power plus battery Autonomy up to 50km
- Battery charger 48V
- Rear gear
- USB port
- Easle
- Mudguard
- Front spoiler with predisposition for FULL LED light

(Certified software)

Mototronik

10979



Handlebar

☆ **STANDARD controls**

☆ Thumb accelerator

☆ Right
12592

Left
12593

Grip throttle

Right
10913

Left
10914

Disc and electronic brake control lever

☆ Right
12594

Left
12595

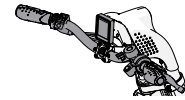

QUADRIPLEGIC controls
Handlebar PUSH&PULL



10905

☆ **MOTOTRONIK 12" wheel**

Motor 250W (750W maximum power)
Maximum speed according to law

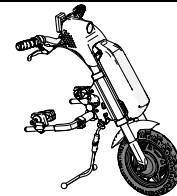

MOTOTRONIK 14" wheel

Motor 1000W (1500W maximum power)
Maximum speed according to law

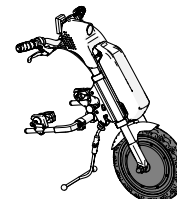

10903

Battery

☆ 48V - 5.8 Ah battery

Autonomy up to 25 km

48V - 11.6 Ah Power plus battery

Autonomy up to 50 km

10904

Date Order User Address

Accessories

FULL LED light (high intensity)
Integrated in the spoiler



10908

Handlebar extension
Adjustable from 15cm up to 23cm

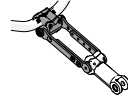

10907

Motor unit facilitated unlock lever
Recommended with handlebar for quadriplegic

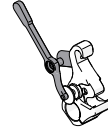

10915

Additional FLY 48V - 2.9 Ah battery
Autonomy up to 15km
Approved for air transport

10906

Rearview mirror

Right
 Left

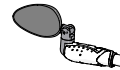

10909
10909

Basket (removable) - (with KLICKfix® attachment system)



10912

Removable front weight - (with KLICKfix® attachment system)
(it increases the weight over the power wheel to improve traction)

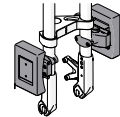

10910

Travel bag

10916

Note

Send this page only if any optional have been chosen

<input checked="" type="checkbox"/>	standard	(supplied if no requests are indicated)
<input type="checkbox"/>	on request	(without extra charge)
<input type="radio"/>	optional	(cost to be added at the basic price)

Date	Order	User	Address
------------	-------------	------------	---------------

SMARTDRIVE - including battery charger



	<p>SWITCH CONTROL (DX+SX) - EU Funzionamento a due pulsanti</p>	<input type="radio"/> 6 KM/H	MX2-S002
		<input type="radio"/> 9 KM/H	MX2-S005



<p>SWITCH CONTROL + JACK 3.5 - EU</p>	<p>"Mono" female input, allows SmartDrive to be connected to any other control/driving device.</p>	<input type="radio"/> 6 KM/H	MX2-S003
		<input type="radio"/> 9 KM/H	MX2-S006

Pulsante di comando esterno BUDDY BUTTON
completo di adattatore, set di montaggio e braccio di estensione
Disponibile solo con SWITCH CONTROL + JACK 3.5

MX2-BBB

ATTACHMENT HARDWARE FOLDER KIT
Choose attachment hardware kit according to the size of the wheelchair's rear wheels

<input type="checkbox"/> Attachment hardware folder kit - rear wheels 22" - 24"	MX2-443-C
<input type="checkbox"/> Attachment hardware folder kit - rear wheels 25"	MX2-453-C
<input type="checkbox"/> Attachment hardware folder kit - rear wheels 26"	MX2-463-C

SMART WATCH

Lo SmartDrive può essere comandato e gestito con uno Smart Watch APPLE o GALAXY
Fast and simple setup
Increased screen visibility
Improved battery performance
Free App from Apple Store and Play Store

Lista compatibilita'



Smart Watch compatibili

APPLE WATCH
serie 5 o successivi con iOS 8 o successivi
Apple iPhone

GALAXY WATCH
serie 4 o successivi
Smartphone Samsung
Smartphone Android 6.0 e RAM almeno 1.5 GB

Applicazioni gratuite

SmartDrive MX2+



Pushtracker



Accessories

<input type="radio"/> Carrying bag	 MX2SD-BAG
<input type="radio"/> Universal padded handle <i>Universal padded handle</i>	 MX2-986

Wheelchair : Progeo EGO - Rev. 2026.0	Prices - VAT excluded to be added to the price list	<p style="text-align: center; font-size: small;">Send this page only if any optional have been chosen</p> <table style="width: 100%; border-collapse: collapse;"> <tr> <td style="width: 10%; text-align: center;">★</td> <td style="width: 60%;">standard</td> <td style="width: 30%; text-align: right; font-size: x-small;">(supplied if no requests are indicated)</td> </tr> <tr> <td style="text-align: center;">□</td> <td>on request</td> <td style="text-align: right; font-size: x-small;">(without extra charge)</td> </tr> <tr> <td style="text-align: center;">○</td> <td>optional</td> <td style="text-align: right; font-size: x-small;">(cost to be added at the basic price)</td> </tr> </table>	★	standard	(supplied if no requests are indicated)	□	on request	(without extra charge)	○	optional	(cost to be added at the basic price)
★	standard	(supplied if no requests are indicated)									
□	on request	(without extra charge)									
○	optional	(cost to be added at the basic price)									