

Date	Progeo (English)	
User	Company stamp	Rigid frame wheelchair
End user wheight (kg)		
Language user manual	Responsible	

Wheelchair measures - The tolerance on all the dimensions indicated and/or required is ± 10 mm							
Seat width (LS)	<input type="checkbox"/> 33	<input type="checkbox"/> 36	<input type="checkbox"/> 39	<input type="checkbox"/> 42	<input type="checkbox"/> 45	<input type="checkbox"/> 48	
The seat width is measured from the outer sides of the frame							
Seat depth (PS)	<input type="checkbox"/> 35	<input type="checkbox"/> 37,5	<input type="checkbox"/> 40	<input type="checkbox"/> 42,5	<input type="checkbox"/> 45	<input type="checkbox"/> 47,5	<input type="checkbox"/> 50
The real seat depth, from the front part of the seat cloth to the backrest tube will be 1,5 cm more than the declared one.							
Footplate distance (DP) (cm) ±0.5cm - adjustment steps 1.5cm						
(Real distance between seat and footplate) - IMPORTANT NOTICE! From the footplate to the floor minimum 4cm !! (Minimum Front height = DP + 4cm)							
Setting	<input checked="" type="checkbox"/> Standard	<input type="checkbox"/> Prudential	<input type="checkbox"/> Active	<input type="checkbox"/> Extreme			
Backrest Height (TS)	Std. Value 33,5(min 26-max 47) adjustment steps 1.5cm						
camber	<input checked="" type="checkbox"/> 0°	<input type="checkbox"/> 2°	<input type="checkbox"/> 4°				

*Carbon fibre frame - Front fork support integrated
Opaque transparent painting*

☆ Alluminum rear adjustment plate

- ☆ Removable mudguard ABS
- Removable ABS fibre straight sideguard
- Removable carbon fibre mudguard
- Removable Carbon fibre straight sideguard

03946

08918

FULL CARBON rear adjustment plate with integrated sideguard - Polished transparent paining
Lightest configuration

07646

☆ Version mudguard (Available only with rear wheels 24")

Front height - Tick the box with the required height
The possible difference in height between HIGH frame and LOW frame is 3cm (with same fork, caster and assembly hole).

	SPORT fork (H95)	Small size fork (H115)
LOW FRAME 90° Front height (min 44,5 - max 50) Footplate distance (min 36)	<i>Casters</i>	<i>Casters</i>
	3" <input type="checkbox"/> ~45 <input type="checkbox"/> ~46	3" <input type="checkbox"/> ~45,5 <input type="checkbox"/> ~47
	4" <input type="checkbox"/> ~46 <input type="checkbox"/> ~47	4" <input type="checkbox"/> ~46,5 <input type="checkbox"/> ~48 <input type="checkbox"/> ~49
	5" <input type="checkbox"/> ~48,5	5" <input type="checkbox"/> ~49 <input type="checkbox"/> ~50
HIGH FRAME 90° Front height (min 47,5 - max 53) Footplate distance (min 39)	<i>Casters</i>	<i>Casters</i>
	3" <input type="checkbox"/> ~48 <input type="checkbox"/> ~49	3" <input type="checkbox"/> ~48,5 <input type="checkbox"/> ~50
	4" <input type="checkbox"/> ~49 <input type="checkbox"/> ~50	4" <input type="checkbox"/> ~49,5 <input type="checkbox"/> ~51 <input type="checkbox"/> ~52
	5" <input type="checkbox"/> ~51,5	5" <input type="checkbox"/> ~52 <input type="checkbox"/> ~53

The real front-seat height could be slightly different from the chosen one considering it is affected by seat depth and rear seat height.

Rear height

The difference between Font Height and Rear Height must be in the 3 - 12 cm range.

- Rear wheels 22" (min 36 - max 44)
- Rear wheels 24" (min 38 - max 46)
- Rear wheels 25" (min 39 - max 47)
- Rear wheels 26" (min 41 - max 48)

Date Order User Address

Footplate

☆ Aluminium footplate, rake adjustable

Internal 2/3 Internal External 2/3 External  **11523**

Aluminium footplate EVOLUTION - rake and depth adjustable

Internal 2/3 Internal External 2/3 External  **07649**

One piece Carbon fibre footplate, rake adjustable

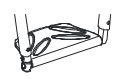
Internal External  **03346**

Seat

☆ Seat cloth with pocket (under seat)

Seat with tension straps **08883**

Carbon rigid seat **08336**

Pocket (under seat) [25x11x4,5] **08281**

Rear wheels axle

☆ Aluminum rear wheels axle

Carbon fiber rear wheels axle *Lightest configuration* **07647**

Backrest adjustment and fixing system

☆ Backrest with double locking (upright and folded) **with rake adjustable from -4° to +16°**

Backrest with upright locking system ONLY (no locking when folded) **with rake adjustable from -4° to +16°**

Fixed back(non-folding back) **with rake adjustable from -4° to +16°**

Backrest

☆ Adjustable velcro straps and padded transpiring upholstery

Aluminium backrest 

Titanium backrest  **06811**

Carbon fibre backrest  **04389**

o AIR Integrated posture backrest (NOT REMOVABLE)
Carbon shell - Lateral retaining 7,5cm
Depth adjustment ±1cm. - Angle adjustment ±10°
not available for seat width 48

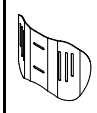
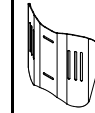
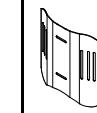
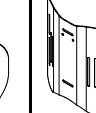
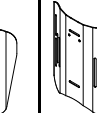
H 28		H 34		H 40	
Backrest Height (TS) min 34 (.....)		Backrest Height (TS) min 38 (.....)		Backrest Height (TS) min 44 (.....)	
Lateral retaining wing A=high - R=regular					
A	R	A	R	A	R
					
<input type="checkbox"/>	<input type="checkbox"/>	<input type="checkbox"/>	<input type="checkbox"/>	<input type="checkbox"/>	<input type="checkbox"/>

Installation on:

☆ Backrest tubes

Aluminium backrest 

Titanium backrest  **06811**

Carbon fibre backrest  **04389**

Date	Order	User	Address
------------	-------------	------------	---------------

Handle tube

☆ Tubes with standard handle

Tubes with short handle

SPORT tubes Without push handles

Carbon fibre tubes with short handle *Lightest configuration* 04390

Not available with: Posture backrest PHYSIO - Posture backrest A I R

Folding handles **Minimum backrest height 30,5cm** 02958

Not available with: Push handles for companion



Casters

☆ 4" Soft

3" Sport *Lightest configuration*

5" Soft

3" Active Soft (wide) (Aluminium alloy rim) 06824

4" Active Sport (narrow) (Aluminium alloy rim) 01398

4" Active Soft (wide) (Aluminium alloy rim) 03943

5" Active Soft (wide) (Aluminium alloy rim) 07518

5" Pneumatic 10844

Colour set: includes rear wheel hub and rim and front forks
Only standard Progeo 22"/24" wheels have coloured hubs and rims

☆ Black 22" 24" 25" 26"

Bright silver 22" 24" 00833

Bright lime 22" 24" 00833

Bright blue 22" 24" 00833

Bright red 22" 24" 00833

Bright fuchsia 22" 24" 00833

POLAR white 22" 24" 00833

Tekno anthracite 22" 24" 00833

Matt Midnight blue 22" 24" 00833

Matt grey 22" 24" 00833

Matt red 22" 24" 00833

Rear wheels

☆ 24" Ultra-light Progeo - Standard!

22" Ultra-light Progeo - Standard!

25" Ultra-light Progeo - Standard! (colour: black)

26" Progeo - Standard! (colour: black)

24" ULTRA-LIGHT PROGEO KEY SPORT *Lightest configuration* 04383

24" Ultra-light "Spinergy LX" 01685

24" Ultra-light "Spinergy LXL" Black hub and white spokes Hub and spokes black 07846

24" Ultra-light "Spinergy Flex rim" Integrated aluminium/rubber handrim 02270

25" Ultra-light "Spinergy LX" 02101

25" Ultra-light "Spinergy LXL" Black hub and white spokes 07847

26" Ultra-light "Spinergy LX" 02102

24" Off-road (aluminium handrim black - Wheel distance 4cm) 01392

Rear wheel tyre

☆ High pressure tyre (22"-24"-25"-26") *Lightest configuration*

High pressure profile tyre (24")

Marathon Plus (24"-25") with anti-puncture protection 01669

Anti-puncture - Colour Grey (22") 04181

Anti-puncture - Colour Black (24") 11083

Not available with Rear wheels : 24" ULTRA-LIGHT PROGEO KEY SPORT, 24" Ultra-light "Spinergy LXL"

	Wheel distance ☆ 3 cm	□ 4 cm	
☆ Aluminium	(22"-24"-25"-26")	<i>Lightest configuration</i>	
<input type="checkbox"/> Aluminium black SOFT-TOUCH	(24"-25")	(24" handrim, on 25" wheel is installed with spacers)	09170
<input type="checkbox"/> Chromed Steel	(24"-25")	(24" handrim, on 25" wheel is installed with spacers)	01684
<input type="checkbox"/> Titanium	(24"-25")	(24" handrim, on 25" wheel is installed with spacers)	00016
<input type="checkbox"/> Ultra Grepp	(24"-25")	(24" handrim, on 25" wheel is installed with spacers)	00017
<input type="checkbox"/> TOP FRICTION	(24"-25")	(24" handrim, on 25" wheel is installed with spacers)	11023
Oval countour with a rubber insert			
<input type="checkbox"/> NOVA H	(24"-25")	(24" handrim, on 25" wheel is installed with spacers)	11025
Ergonomic black profile			
<input type="checkbox"/> NOVA D	(24"-25")	(24" handrim, on 25" wheel is installed with spacers)	11026
Ergonomic profile with rubber coating (ideal for quadriplegics)			
<input type="checkbox"/> Silicon cover for standard aluminium handrim		Available for measures (22"- 24" - 26")	04050

Date	Order	User	Address
------------	-------------	------------	---------------

Wheel locks

Bent lever push to lock

Straight lever push to lock

Straight lever pull to lock

Sport brake *Lightest configuration*

Brake with extension lever push to lock

Brake with extension lever pull to lock

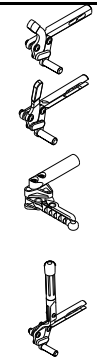

06428

01949

03372

Armrests

Tubular armrests (Swing away, removable and height adjustable armrest)



00694

Accessories

Pad for front frame protectors 07058

Backrest-seat connection cloth 10241

Removable storage bag (with quick coupling) 09811

Optional 1

Only one optional devices for side can be chosen

Transit wheels Exclude the installation of Anti-tippers 03290

Anti-tippers - Easy Swing Away - (Non removable) - Exclude the installation of Transit wheels

Rotatable and lockable 90°
It is possible to install anti-tipping on one side only

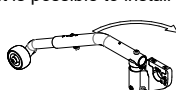

Right 13162

Left 13163

Rotatable and lockable 90° - 180°

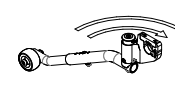

Right 13164

Left 13165

Anti-tipper with rapid hookup
(inside rotation to reduce the encumbrance) Exclude the installation of Transit wheels

Right 06821

Left 06822



Optional 2

Push handles for companion (Removable and height adjustable) 03645

Tetracclip (Quick release axle for quadriplegic) 03947

Safety pelvic belt 03972

Harness 04103

Lumbar support (to insert in the backrest upholstery) 00013

Swing away lateral support
Prevents backrest folding Not available with Posture backrest PHYSIO - Posture backrest A I R

Right 02097

Left 02098



Spoke guards Black (22"-24") 01043

Spoke guards Transparent (22"-24") 00835

Spoke guards Progeo design (22"-24") 00019

Additional Kit

24" Off-road rear wheels Off-Road tyre - aluminium handrim (black colour) 03378







24" FAT rear wheels FAT tyre 3" - aluminium handrim (black colour) 09357

Date Order User Address





PHYSIO - Posture backrest
(Std. Backrest upholstery not provided)

Removable with quick release
Suitable for tubes with diameter 18+26mm
Depth adjustment (4cm)
Angle adjustment (±18°)

- AIR** Carbon shell
not available for seat width 48

BACKREST HEIGHT	28	34	40			
Shell's shape  7.5 cm	Lateral retaining wing A=high - R=regular					
	A	R	A	R	A	R
						
	<input type="checkbox"/>	<input type="checkbox"/>	<input type="checkbox"/>	<input type="checkbox"/>	<input type="checkbox"/>	<input type="checkbox"/>

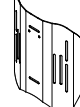
- POSTURE** Aluminum shell

BACKREST HEIGHT	34	40	52
Shell's shape  7.5 cm	Lateral retaining wing R=regular		
	R	R	R
			
	<input type="checkbox"/>	<input type="checkbox"/>	<input type="checkbox"/>

Configuration DEEP with side support PAD (height adjustable)

Alluminum lateral with padded, breathable upholstery.



Small (h 13cm)



Right
10272

Left
10272

Large (h 20cm)



Right
10273

Left
10273

SWING AWAY - Lateral support

Fixing and adjustment hardware complete with protection sleeve
Alluminum lateral with padded, breathable upholstery.

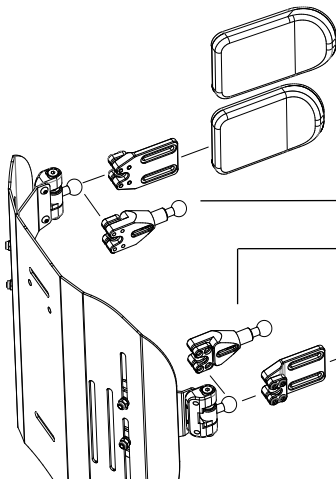

Large (18x12)

05647

Small (14x9)

05643

Lateral support extension

Quantity (number pcs).....
10271

Lateral support extension

Quantity (number pcs).....

Small (14x9)

05642

Large (18x12)

05646

- Headrest adjustable - Double ball mounting system

Available only with backrest Physio Posture



- Large (35x12,5)
- Small (25x12,5)

05648

Date	Order	User	Address
------------	-------------	------------	---------------

12" wheel - Motor 250W (750W maximum power)
 14" wheel - Motor 1000W (1500W maximum power)

- Color display with switcher
- Maximum speed limit settable from display
- 5 speed levels selectable
- 10 display-selectable acceleration levels
- Adaptive Cruise Control
- Disc and electronic brake control lever
- Motor brake (adjustable in 10 levels from the display)
- Electronic brake with control bottom (adjustable in 10 levels from the display)
- Power regain when braking
- Error messages management from display (with error history)
- Rear gear beeper
- 48V - 5.8 Ah battery Autonomy up to 25km
- 48V - 11.6 Ah Power plus battery Autonomy up to 50km
- Battery charger 48V
- Rear gear
- USB port
- Easle
- Mudguard
- Front spoiler with predisposition for FULL LED light

(Certified software)

Mototronik

10979



Handlebar

☆ **STANDARD controls**

☆ Thumb accelerator

☆ Right
12592

Left
12593

Grip throttle

Right
10913

Left
10914

Disc and electronic brake control lever

☆ Right
12594

Left
12595

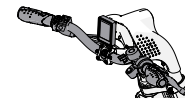

QUADRIPLEGIC controls
 Handlebar PUSH&PULL

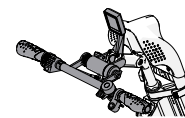

10905

☆ **MOTOTRONIK 12" wheel**

Motor 250W (750W maximum power)
 Maximum speed according to law

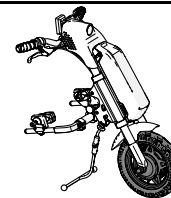

MOTOTRONIK 14" wheel

Motor 1000W (1500W maximum power)
 Maximum speed according to law

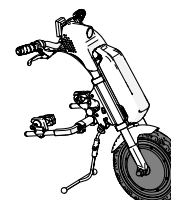

10903

Battery

☆ 48V - 5.8 Ah battery

Autonomy up to 25 km

48V - 11.6 Ah Power plus battery

Autonomy up to 50 km

10904

Date Order User Address

Accessories

FULL LED light (high intensity)
Integrated in the spoiler



10908

Handlebar extension
Adjustable from 15cm up to 23cm

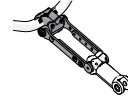

10907

Motor unit facilitated unlock lever
Recommended with handlebar for quadriplegic

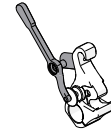

10915

Additional FLY 48V - 2.9 Ah battery
Autonomy up to 15km
Approved for air transport

10906

Rearview mirror

Right
 Left

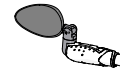

10909
10909

Basket (removable) - (with KLICKfix® attachment system)



10912

Removable front weight - (with KLICKfix® attachment system)
(it increases the weight over the power wheel to improve traction)

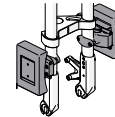

10910

Travel bag

10916

Note

Send this page only if any optional have been chosen

<input checked="" type="checkbox"/>	standard	(supplied if no requests are indicated)
<input type="checkbox"/>	on request	(without extra charge)
<input type="radio"/>	optional	(cost to be added at the basic price)

Date Order User Address

SMARTDRIVE - including battery charger



 SWITCH CONTROL (DX+SX) - EU Funzionamento a due pulsanti	<input type="radio"/> 6 KM/H	MX2-S002
	<input type="radio"/> 9 KM/H	MX2-S005

 SWITCH CONTROL + JACK 3.5 - EU "Mono" female input, allows SmartDrive to be connected to any other control/driving device.	<input type="radio"/> 6 KM/H	MX2-S003
	<input type="radio"/> 9 KM/H	MX2-S006

Pulsante di comando esterno BUDDY BUTTON
 completo di adattatore, set di montaggio e braccio di estensione
Disponibile solo con SWITCH CONTROL + JACK 3.5



MX2-BBB

ATTACHMENT HARDWARE FIX FRAME KIT
 Choose attachment hardware kit according to the size of the wheelchair's rear wheels



Attachment hardware fix frame kit - rear wheels 22" - 24" MX2-44S-C

Attachment hardware fix frame kit - rear wheels 25" MX2-45S-C

Attachment hardware fix frame kit - rear wheels 26" MX2-46S-C

SMART WATCH

Lo SmartDrive può essere comandato e gestito con uno Smart Watch APPLE o GALAXY
 Fast and simple setup
 Increased screen visibility
 Improved battery performance
 Free App from Apple Store and Play Store

<p><u>Listina compatibilita'</u></p> 	<p>Smart Watch compatibili</p> <p>APPLE WATCH serie 5 o successivi con iOS 8 o successivi Apple iPhone</p>	<p>Applicazioni gratuite</p> <p>SmartDrive MX2+ </p> <p>Pushtracker </p>
	<p>GALAXY WATCH serie 4 o successivi Smartphone Samsung Smartphone Android 6.0 e RAM almeno 1.5 GB</p>	

Accessories

Carrying bag  MX2SD-BAG

Universal padded handle
Universal padded handle  MX2-986

Wheelchair : Progeo JOKER CARBON - Rev. 2026.0	Prices - VAT excluded to be added to the price list	<p align="center">Send this page only if any optional have been chosen</p> <input checked="" type="checkbox"/> standard (supplied if no requests are indicated) <input type="checkbox"/> on request (without extra charge) <input type="radio"/> optional (cost to be added at the basic price)
--	--	---