

Date	Order	User	Address
------------	-------------	------------	---------------

Casters

☆ 5" Soft

4" Soft

3" Sport *Lightest configuration*

6" Soft

6" Pneumatic

3" Active Soft (wide) (Aluminium alloy rim) 06824

4" Active Sport (narrow) (Aluminium alloy rim) 01398

4" Active Soft (wide) (Aluminium alloy rim) 03943

5" Active Soft (wide) (Aluminium alloy rim) 07518

5" Pneumatic 10844

Rear wheels

☆ 24" Ultra-light Progeo - Standard!

22" Ultra-light Progeo - Standard!

24" ULTRA-LIGHT PROGEO KEY SPORT *Lightest configuration* 04383

24" Ultra-light "Spinergy LX" 01685

24" Ultra-light "Spinergy LXL" 07846

24" Ultra-light "Spinergy Flex rim" 02270

24" Off-road (aluminium handrim black - Wheel distance 4cm) 01392

24" with brake handles for companion (drum brake) (aluminium handrim - Wheel distance 3cm) 03384

Available only with camber 0

Not available with Frame Dynamic 2.0

One arm drive - (24" rear wheels Aluminium handrim High pressure Tyre) - camber 0° 02103

Right Left

Rear wheel tyre

☆ High pressure tyre (22"-24") *Lightest configuration*

High pressure profile tyre (24")

Marathon Plus (24") with anti-puncture protection 01669

Anti-puncture - Colour Black (24") 11083

Not available with Rear wheels : 24" ULTRA-LIGHT PROGEO KEY SPORT, 24" Ultra-light "Spinergy LXL"

Anti-puncture - Colour Grey (22") 04181

Handrim **Wheel distance** ☆ 3 cm 4 cm

☆ Aluminium (22"-24") *Lightest configuration*

Aluminium black SOFT-TOUCH (24") 09170

Chromed Steel (24") 01684

Titanium (24") 00016

Ultra Grepp (24") 00017

TOP FRICTION (24") 11023

Oval countour with a rubber insert

NOVA H (24") 11025

Ergonomic black profile

NOVA D (24") 11026

Ergonomic profile with rubber coating (ideal for quadriplegics)

Silicon cover for standard aluminium handrim Available for measures (22"-24") 04050

Wheel locks

☆ Bent lever push to lock 

Straight lever push to lock 

Straight lever pull to lock

Sport brake  06428

Brake with extension lever push to lock  01949

Brake with extension lever pull to lock  03372

Footplate - See reference tables N°3

☆ Plastic footrest with multifunction rotative system  11739

(Minimum footplate distance 16,5cm.)

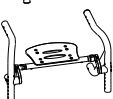
One piece aluminium footplate - Flip-up! with multifunction rotative system  11740

(Minimum footplate distance 16,5cm.)

Date Order User Address

Mudguard
Mudguard - FIXED
 ABS mudguard
 ABS Straight sideguard
 Carbon fibre mudguard
 Carbon fibre Straight sideguard

Mudguard - REMOVABLE
The distance between the two side guards is 1 cm wider than the seat width
 Removable ABS mudguard
 Removable ABS fibre straight sideguard
 Removable carbon fibre mudguard
 Removable Carbon fibre straight sideguard



03946
08918



08921
08921
08919
08920

Armrests
Tubular armrests with standard support combined with anti-tipper wheels exclude the possibility of installing the transit wheels.
 Tubular armrests (Swing away, removable and height adjustable armrest)
 Standard Support (Not with frame Dynamic)
 Steel support with safety locking system

Removable armrest with integrated mudguard

Desk armrests PROGEO (Removable and height adjustable)
 Not available with Frame Dynamic 2.0 + camber 4°

Enlargement of Desk armrests PROGEO
 + 0 cm
 + 2 cm Available only with Ultra-light Progeo standard wheels and camber 0°

Removable armrest with ABS straight sideguard
The distance between the two side guards is 1 cm wider than the seat width
 Removable armrest with carbon-fiber straight sideguard
The distance between the two side guards is 1 cm wider than the seat width



04828
00694



09956



08881
08882

Accessories
 Pad for front frame protectors 07058
 Backrest-seat connection cloth 10241
 Removable storage bag (with quick coupling) 09811

Optional 1
 Anti-tipper with rapid hookup - (inside rotation to reduce the encumbrance)
 The first is provided free of charge ☆ Right Left
 The second has extra charge Right Left

Transit wheels

Push handles for companion (Removable and height adjustable)

Tipping aid Right Left

Crutches support Right Left



00023
00024



00836



01048



00025
01046



00838
00837

Optional 2
 Quick release front forks 00030
 Tetraclip (Quick release axle for quadriplegic) 03947
 Safety pelvic belt 03972
 Harness 04103
 Tray table (removable) 00508
 Lumbar support (to insert in the backrest upholstery) 00013
 Swing away lateral support Right Left
 Not available with Posture backrest PHYSIO Left

Spoke guards Black (22"-24") 01043
 Spoke guards Transparent (22"-24") 00835
 Spoke guards Progeo design (22"-24") 00019



02097
02098

Additional Kit
 24" Off-road rear wheels Off-Road tyre - aluminium handrim (black colour) 03378
 24" FAT rear wheels FAT tyre 3" - aluminium handrim (black colour) 09357

Date Order User Address



PHYSIO - Std. Backrest upholstery not provided

Removable with quick release
Suitable for tubes with diameter 18+26mm
Depth adjustment (4cm)
Angle adjustment ($\pm 18^\circ$)

Posture backrest KID JUNIOR VERSION



- KID** Aluminum shell

WARNING: with this backrest the seat depth is reduced by 5 cm approx.



BACKREST HEIGHT	29	34	40
Shell's shape	Lateral retaining wing R=regular		
	R	R	R
 	<input type="checkbox"/>	<input type="checkbox"/>	<input type="checkbox"/>

Posture backrest ADULT VERSION

- AIR** Carbon shell
not available for seat width 27 - 30

BACKREST HEIGHT	28	34	40
Shell's shape	Lateral retaining wing A=high - R=regular		
	A	R	A
	R	A	R
 	<input type="checkbox"/>	<input type="checkbox"/>	<input type="checkbox"/>

- POSTURE** Aluminum shell
not available for seat width 27 - 30

BACKREST HEIGHT	34	40	52
Shell's shape	Lateral retaining wing R=regular		
	R	R	R
 	<input type="checkbox"/>	<input type="checkbox"/>	<input type="checkbox"/>

Configuration DEEP with side support PAD (height adjustable)

Alluminum lateral with padded, breathable upholstery.



Small (h 13cm)



Right 10272

Left 10272

Large (h 20cm)



Right 10273

Left 10273

Date Order User Address

Accessories

KID AIR POSTURE

SWING AWAY - Lateral support
Not available for backrest Physio AIR carbon shell
Fixing and adjustment hardware complete with protection sleeve
Alluminum lateral with padded, breathable upholstery.

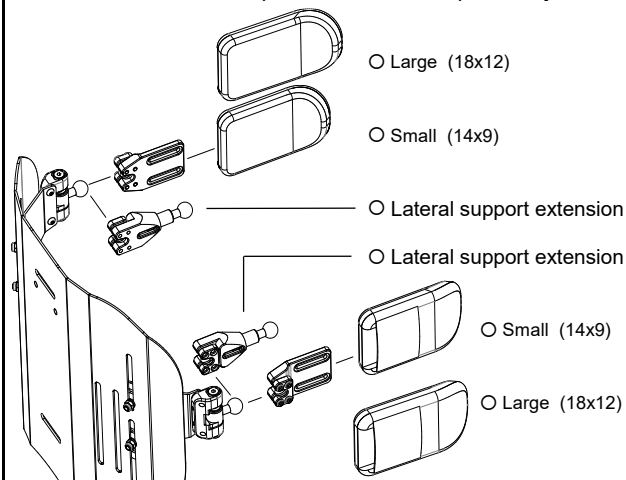

Large (18x12) 05647

Small (14x9) 05643

Lateral support extension Quantity (number pcs).....

10271

Lateral support extension Quantity (number pcs).....

Small (14x9) 05642

Large (18x12) 05646

Headrest adjustable - Double ball mounting system
Available only with backrest Physio Posture and Kid

Large (35x12,5) 05648
 Small (25x12,5)





Empty space for additional notes or specifications.



Empty space for additional notes or specifications.

Wheelchair : Progeo EXELLE JUNIOR - Rev. 2026.0	Prices - VAT excluded to be added to the price list	Send this page only if any optional have been chosen
		<input checked="" type="checkbox"/> standard <small>(supplied if no requests are indicated)</small> <input type="checkbox"/> on request <small>(without extra charge)</small> <input type="radio"/> optional <small>(cost to be added at the basic price)</small>

REFERENCE TABLES

1		Front height				
With closed frame (100°) max 5" caster						
FORK		Casters				
		3"	4"	5"	6"	7"
SMALL 	min.	36	37	38		
	max	51	52	53		
MEDIUM 	min.	40	41	42	43	
	max	55	56	57	58	
LONG 	min.	44	45	46	47	
	max	59	60	61	62	

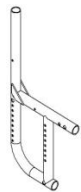
The size of the fork will be defined only by Progeo in accordance with wheelchair final configuration.

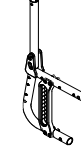
2		Rear height			
Rear frame		Rear wheels			
		22"	24"	25"	26"
STANDARD 	Straight plate 	min. 37 max 45	min. 39 max 47		
	Shaped plate 	min. 36 max 49	min. 38 max 51		
DYNAMIC 2.0 		min. 36 max 49	min. 38 max 51		

3		Footplate option	Footplate distance
		Plastic footrest	min. 16,5 max 40
		One piece aluminium footplate - Flip-up!	min. 16,5 max 40
<p>Calculated with the best configuration and with the footplates positioned on inside.</p> <p>IMPORTANT NOTICE! From the footplate to the floor minimum 4cm !! (Minimum Front height = DP + 4cm)</p>			

4			Rear wheels
Model	Features	Handrim and tyre	
22" Ultra-light Progeo - Standard!	(not available in anthracite color)	(aluminium handrim and high pressure tyre)	
24" Ultra-light Progeo - Standard!	(available for all colors)	(all handrim and tyre)	
24" ULTRA-LIGHT PROGEO KEY SPORT	(silver hub, black rim and 16 spokes)	(all handrim and tyre)	
24" Ultra-light "Spinergy LX"	(silver hub, black rim and spokes)	(all handrim and tyre)	
24" Ultra-light "Spinergy LXL"	(black hub and rim, 18 white spokes)	(all handrim and tyre)	
24" Ultra-light "Spinergy Flex rim"	(silver hub, black rim and spokes)	(integrated aluminium/rubber handrim - encumbrance reduction up to 3cm. - all tyre)	
24" Off-road	(colour: black)	(aluminium handrim - tyre Off-road)	

Date Order User Address

SMARTDRIVE - including battery charger



 SWITCH CONTROL (DX+SX) - EU Funzionamento a due pulsanti	<input type="radio"/> 6 KM/H	MX2-S002
	<input type="radio"/> 9 KM/H	MX2-S005

 SWITCH CONTROL + JACK 3.5 - EU "Mono" female input, allows SmartDrive to be connected to any other control/driving device.	<input type="radio"/> 6 KM/H	MX2-S003
	<input type="radio"/> 9 KM/H	MX2-S006

Pulsante di comando esterno BUDDY BUTTON
 completo di adattatore, set di montaggio e braccio di estensione
Disponibile solo con SWITCH CONTROL + JACK 3.5



MX2-BBB

ATTACHMENT HARDWARE FOLDER KIT
 Choose attachment hardware kit according to the size of the wheelchair's rear wheels



Attachment hardware folder kit - rear wheels 22" - 24" MX2-443-C

Attachment hardware folder kit - rear wheels 25" MX2-453-C

Attachment hardware folder kit - rear wheels 26" MX2-463-C

SMART WATCH

Lo SmartDrive può essere comandato e gestito con uno Smart Watch APPLE o GALAXY
 Fast and simple setup
 Increased screen visibility
 Improved battery performance
 Free App from Apple Store and Play Store

<p><u>Lista compatibilita'</u></p> 	<p>Smart Watch compatibili</p> <p>APPLE WATCH serie 5 o successivi con iOS 8 o successivi Apple iPhone</p> <p>GALAXY WATCH serie 4 o successivi Smartphone Samsung Smartphone Android 6.0 e RAM almeno 1.5 GB</p>	<p>Applicazioni gratuite</p> <p>SmartDrive MX2+ </p> <p>Pushtracker </p>
--	---	--

Accessories

Carrying bag  MX2SD-BAG

Universal padded handle
Universal padded handle  MX2-986

Wheelchair : Progeo EXELLE JUNIOR - Rev. 2026.0	Prices - VAT excluded to be added to the price list	<p align="center">Send this page only if any optional have been chosen</p> <input checked="" type="checkbox"/> standard (supplied if no requests are indicated) <input type="checkbox"/> on request (without extra charge) <input type="radio"/> optional (cost to be added at the basic price)
---	--	---