

Date User End user weight (kg) Language user manual	Progeo (English) Company stamp Responsible	Rigid tilting frame wheelchair
--	--	--------------------------------

Information on end user	
End user pathology :	
Presence of dystonia or important spasms : <input type="checkbox"/> YES <input type="checkbox"/> NO	End user weight (kg):.....Kg

Wheelchair measures - The tolerance on all the dimensions indicated and/or required is ± 10 mm	
MODEL ADULT	MODEL JUNIOR
Seat width (LS) <input type="checkbox"/> 33 <input type="checkbox"/> 36 <input type="checkbox"/> 39 <input type="checkbox"/> 42 <input type="checkbox"/> 45 <input type="checkbox"/> 48 kit to increase seat width (LS + 3cm) - included on the basic price <input type="checkbox"/> Not mounted (LS) <input type="checkbox"/> Mounted (LS + 3cm)	Seat width (LS) <input type="checkbox"/> 30 <input type="checkbox"/> 33 <input type="checkbox"/> 36 <input type="checkbox"/> 39 kit to increase seat width (LS + 3cm) - included on the basic price <input type="checkbox"/> Not mounted (LS) <input type="checkbox"/> Mounted (LS + 3cm)

Seat depth (PS) - adjustable!			Backrest tube position
Short frame	Medium frame	Long frame	
<input type="checkbox"/> 35 <input type="checkbox"/> 37,5 <input type="checkbox"/> 40 	<input type="checkbox"/> 40 <input type="checkbox"/> 42,5 <input type="checkbox"/> 45 	<input type="checkbox"/> 45 <input type="checkbox"/> 47,5 <input type="checkbox"/> 50 	

Footplate distance (DP) - (Real distance between seat and footplate)	
<i>IMPORTANT NOTICE! From the footplate to the floor minimum 4cm !! (Minimum Front height = DP + 4cm)</i>	
Minimum footplate distance ~22cm <input style="width: 50px;" type="text"/> (cm)	±0.5cm - adjustment steps 1.5cm

Seat height (parallel to the ground)																																																									
CASTERS 6" <table border="1" style="width:100%; border-collapse: collapse;"> <tr> <th colspan="4" style="text-align: center;">Rear wheels</th> </tr> <tr> <th style="width:25%;">12"</th> <th style="width:25%;">16"</th> <th style="width:25%;">22"</th> <th style="width:25%;">24"</th> </tr> <tr> <td><input type="checkbox"/> 42</td> <td></td> <td><input type="checkbox"/> 42</td> <td></td> </tr> <tr> <td>☆ 43,3</td> <td></td> <td><input type="checkbox"/> 43,3</td> <td><input type="checkbox"/> 43,3</td> </tr> <tr> <td><input type="checkbox"/> 44,5</td> <td></td> <td><input type="checkbox"/> 44,5</td> <td><input type="checkbox"/> 44,5</td> </tr> <tr> <td><input type="checkbox"/> 45,8</td> <td></td> <td><input type="checkbox"/> 45,8</td> <td><input type="checkbox"/> 45,8</td> </tr> <tr> <td><input type="checkbox"/> 47</td> <td><input type="checkbox"/> 47</td> <td><input type="checkbox"/> 47</td> <td><input type="checkbox"/> 47</td> </tr> <tr> <td></td> <td><input type="checkbox"/> 48,3</td> <td><input type="checkbox"/> 48,3</td> <td><input type="checkbox"/> 48,3</td> </tr> </table>	Rear wheels				12"	16"	22"	24"	<input type="checkbox"/> 42		<input type="checkbox"/> 42		☆ 43,3		<input type="checkbox"/> 43,3	<input type="checkbox"/> 43,3	<input type="checkbox"/> 44,5		<input type="checkbox"/> 44,5	<input type="checkbox"/> 44,5	<input type="checkbox"/> 45,8		<input type="checkbox"/> 45,8	<input type="checkbox"/> 45,8	<input type="checkbox"/> 47	<input type="checkbox"/> 47	<input type="checkbox"/> 47	<input type="checkbox"/> 47		<input type="checkbox"/> 48,3	<input type="checkbox"/> 48,3	<input type="checkbox"/> 48,3	CASTERS 7" <table border="1" style="width:100%; border-collapse: collapse;"> <tr> <th colspan="4" style="text-align: center;">Rear wheels</th> </tr> <tr> <th style="width:25%;">12"</th> <th style="width:25%;">16"</th> <th style="width:25%;">22"</th> <th style="width:25%;">24"</th> </tr> <tr> <td><input type="checkbox"/> 44,5</td> <td></td> <td><input type="checkbox"/> 44,5</td> <td><input type="checkbox"/> 44,5</td> </tr> <tr> <td><input type="checkbox"/> 45,8</td> <td></td> <td><input type="checkbox"/> 45,8</td> <td><input type="checkbox"/> 45,8</td> </tr> <tr> <td><input type="checkbox"/> 47</td> <td><input type="checkbox"/> 47</td> <td><input type="checkbox"/> 47</td> <td><input type="checkbox"/> 47</td> </tr> <tr> <td></td> <td><input type="checkbox"/> 48,3</td> <td><input type="checkbox"/> 48,3</td> <td><input type="checkbox"/> 48,3</td> </tr> </table>	Rear wheels				12"	16"	22"	24"	<input type="checkbox"/> 44,5		<input type="checkbox"/> 44,5	<input type="checkbox"/> 44,5	<input type="checkbox"/> 45,8		<input type="checkbox"/> 45,8	<input type="checkbox"/> 45,8	<input type="checkbox"/> 47	<input type="checkbox"/> 47	<input type="checkbox"/> 47	<input type="checkbox"/> 47		<input type="checkbox"/> 48,3	<input type="checkbox"/> 48,3	<input type="checkbox"/> 48,3
Rear wheels																																																									
12"	16"	22"	24"																																																						
<input type="checkbox"/> 42		<input type="checkbox"/> 42																																																							
☆ 43,3		<input type="checkbox"/> 43,3	<input type="checkbox"/> 43,3																																																						
<input type="checkbox"/> 44,5		<input type="checkbox"/> 44,5	<input type="checkbox"/> 44,5																																																						
<input type="checkbox"/> 45,8		<input type="checkbox"/> 45,8	<input type="checkbox"/> 45,8																																																						
<input type="checkbox"/> 47	<input type="checkbox"/> 47	<input type="checkbox"/> 47	<input type="checkbox"/> 47																																																						
	<input type="checkbox"/> 48,3	<input type="checkbox"/> 48,3	<input type="checkbox"/> 48,3																																																						
Rear wheels																																																									
12"	16"	22"	24"																																																						
<input type="checkbox"/> 44,5		<input type="checkbox"/> 44,5	<input type="checkbox"/> 44,5																																																						
<input type="checkbox"/> 45,8		<input type="checkbox"/> 45,8	<input type="checkbox"/> 45,8																																																						
<input type="checkbox"/> 47	<input type="checkbox"/> 47	<input type="checkbox"/> 47	<input type="checkbox"/> 47																																																						
	<input type="checkbox"/> 48,3	<input type="checkbox"/> 48,3	<input type="checkbox"/> 48,3																																																						

Front frame	Front frame, swing away, and removable
☆ Straight frame <input type="checkbox"/> Frame with abduction 6cm not available for seat width 42 - 45 - 48 Maximum footplate distance 40 <input type="checkbox"/> Elevating front frame, swing away and removable not available for seat width 30 - 33 Minimum footplate distance 22cm. Include calf supports and plastic footrest with heel band	 ☆ 110° <input type="checkbox"/> 120° <input type="checkbox"/> 95° (Exclude the installation of casters 7") <input type="checkbox"/> 95° (Not available casters 7")

Date Order User Address

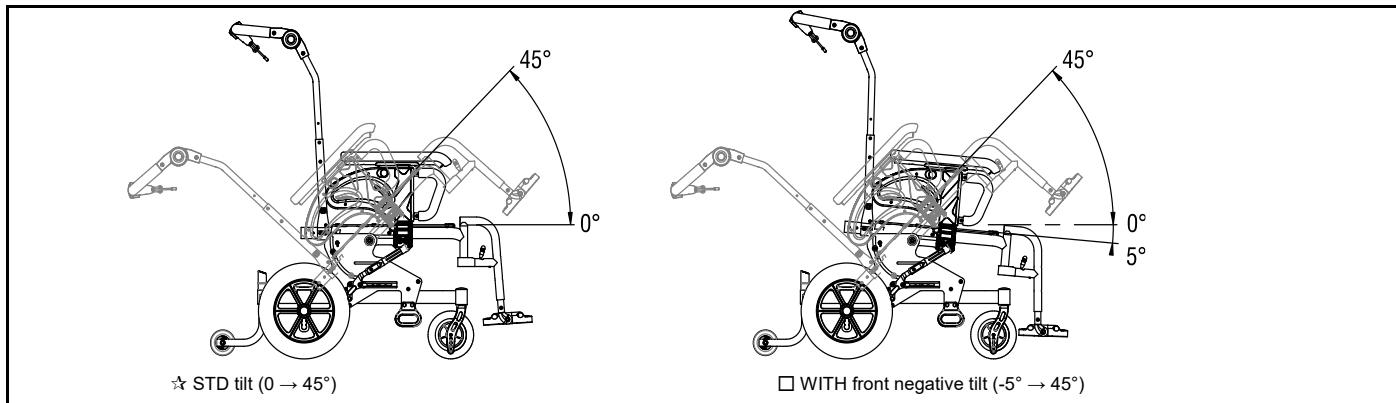

SAFETY
 4 points tie-down system rings
 (installation must be carried out by the manufacturer)
 A head restraint suitable for transportation must be available and fitted accordingly during transportation.

CRASH TEST APPROVED  **08654**
STANDARD EN 1776-01

Frame colour (without extra charge)

<input checked="" type="radio"/> Opaque black	<input type="checkbox"/> AVIO blue	<input type="checkbox"/> POLAR white	<input type="checkbox"/> Matt orange
	<input type="checkbox"/> Tekno anthracite	<input type="checkbox"/> Matt grey	<input type="checkbox"/> Matt red

Frame colour on request

<input type="radio"/> Bright red	<input type="radio"/> Bright fuchsia	<input type="radio"/> Bright lime	<input type="radio"/> Bright blue china	09729
----------------------------------	--------------------------------------	-----------------------------------	---	--------------

Backrest

Reclining and folding backrest
 Easy adjustment of the reclining on three positions

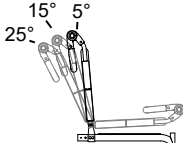

One piece Push handle for companion

Free positioning

It allows the positioning of the height of the one push handle according to the helper (independent from the backrest height - quick setting)

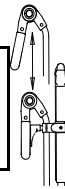

01048

Backrest upholstery

WITH NO backrest upholstery, NOR tension adjustment straps
Backrest Height (TS) 42 48 Available until 54cm

WITH backrest upholstery and tension adjustment straps. Complete with backrest-seat connection cloth. **04693**
 With fixed back(non-folding back)->minimum height 39cm
Backrest Height (TS) 42 48 Available until 54cm

Casters

6" Soft
 6" Pneumatic
 7" Soft

Not available with: Front frame 95°

Rear wheels

12" transit rear wheels - Anti-puncture

12" transit rear wheels - Pneumatic
 16" transit rear wheels - Pneumatic

24" Ultra-light Progeo - Standard! **04696**
 22" Ultra-light Progeo - Standard! **04696**
 24" Ultra-light "Spinergy LX" **04691**
 24" Ultra-light "Spinergy LXL" Black hub and white spokes Hub and spokes black **07848**
 24" Ultra-light "Spinergy Flex rim" Integrated aluminium/rubber handrim **02270**
 24" Off-road (aluminium handrim black - Wheel distance 4cm) **04690**

12" with brake handles for companion (drum brake) Anti-puncture Pneumatic **04105**
 16" with brake handles for companion (drum brake) - Pneumatic **04107**
 24" with brake handles for companion (drum brake) (aluminium handrim - Wheel distance 3cm) **03384**

Colour rear wheels
Only standard Progeo 22"/24" wheels have coloured hubs and rims

<input checked="" type="radio"/> Black	22" 24"	
<input type="radio"/> Bright silver	22" 24"	00833
<input type="radio"/> Bright lime	22" 24"	00833
<input type="radio"/> Bright blue	22" 24"	00833
<input type="radio"/> Bright red	22" 24"	00833
<input type="radio"/> Bright fuchsia	22" 24"	00833
<input type="radio"/> POLAR white	22" 24"	00833
<input type="radio"/> Tekno anthracite	22" 24"	00833
<input type="radio"/> Matt Midnight blue	22" 24"	00833
<input type="radio"/> Matt grey	22" 24"	00833
<input type="radio"/> Matt red	22" 24"	00833

Date	Order	User	Address
------------	-------------	------------	---------------

Handrim	Wheel distance <input checked="" type="checkbox"/> 3 cm <input type="checkbox"/> 4 cm	
<input checked="" type="radio"/> Aluminium	(22-24")	
<input type="radio"/> Aluminium black SOFT-TOUCH	(24")	09170
<input type="radio"/> Chromed Steel	(24")	01684
<input type="radio"/> Titanium	(24")	00016
<input type="radio"/> Ultra Grepp	(24")	00017
<input type="radio"/> TOP FRICTION	(24")	11023
Oval countour with a rubber insert		
<input type="radio"/> NOVA H	(24")	11025
Ergonomic black profile		
<input type="radio"/> NOVA D	(24")	11026
Ergonomic profile with rubber coating (ideal for quadriplegics)		
<input type="radio"/> Silicon cover for standard aluminium handrim		04050

Rear wheel tyre		
<input checked="" type="radio"/> High pressure tyre	(22-24")	
<input type="checkbox"/> High pressure profile tyre	(24")	
<input type="radio"/> Marathon Plus	(24")	01669
with anti-puncture protection		
<input type="radio"/> Anti-puncture - Colour Grey	(22")	04181
<input type="radio"/> Anti-puncture - Colour Black	(24")	11083
Not available with Rear wheels : 24" Ultra-light "Spinergy LXL"		

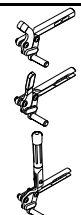
Wheel locks		
<input checked="" type="radio"/> Bent lever push to lock		
<input type="checkbox"/> Straight lever push to lock		
<input type="checkbox"/> Straight lever pull to lock		
<input type="radio"/> Brake with extension lever push to lock		
<input type="radio"/> Brake with extension lever pull to lock		03372

Footplate (Not available with Elevating front frame, swing away and removable)		
<input checked="" type="radio"/> Plastic footrest, rake adjustable		11525
Minimum footplate distance ~19cm		
Not available with: Front frame with levating footrest, swing away and removable		
<input type="checkbox"/> One piece aluminium footplate - Flip-up! rake and depth adjustable		09727
Not available for seat width 30 with straight front frame		
Minimum footplate distance ~18cm		
Not available with: Front frame with levating footrest, swing away and removable		
<input type="checkbox"/> Internal <input checked="" type="checkbox"/> 2/3 Internal <input type="checkbox"/> 2/3 External <input type="checkbox"/> External		

Removable armrest with integrated mudguard		
<input checked="" type="radio"/> Desk armrests PROGEO	(Removable and height adjustable)	

Accessories		
<input type="radio"/> Pad for front frame protectors		07058
<input type="radio"/> Removable storage bag (with quick coupling)		09811

Optional 1		
<input checked="" type="radio"/> Anti-tipper with tipping aid integrated	(inside rotation to reduce the encumbrance)	
INCLUDED ON THE BASIC PRICE		
<input type="radio"/> Anti-tippers with rapid hookup	(inside rotation to reduce the encumbrance)	11033
<input type="radio"/> Transit wheels		00836
<input type="radio"/> Tipping aid	<input type="radio"/> Right <input type="radio"/> Left	00025 01046
<input type="radio"/> Crutches support	<input type="radio"/> Right <input type="radio"/> Left	00838 00837

Optional 2		
<input type="radio"/> Harness		04103
<input type="radio"/> Safety pelvic belt		03972
<input type="radio"/> Tray table (removable)		00508
<input type="radio"/> Lumbar support	(to insert in the backrest upholstery)	00013
<input type="radio"/> Spoke guards Black	(22-24")	01043
<input type="radio"/> Spoke guards Transparent	(22-24")	00835
<input type="radio"/> Spoke guards Progeo design	(22-24")	00019

Date Order User Address





PHYSIO - Std. Backrest upholstery not provided

Removable with quick release
Suitable for tubes with diameter 18+26mm
Depth adjustment (4cm)
Angle adjustment (±18°)

Posture backrest KID JUNIOR VERSION









- KID** Aluminum shell

WARNING: with this backrest the seat depth is reduced by 5 cm approx.





BACKREST HEIGHT	29	34	40
Shell's shape	Lateral retaining wing R=regular		
	R	R	R
 	<input type="checkbox"/>	<input type="checkbox"/>	<input type="checkbox"/>
			

Posture backrest ADULT VERSION

- AIR** Carbon shell
not available for seat width 30

BACKREST HEIGHT	28	34	40
Shell's shape	Lateral retaining wing A=high - R=regular		
	A	R	A
	R	R	R
 	<input type="checkbox"/>	<input type="checkbox"/>	<input type="checkbox"/>
			
			

- POSTURE** Aluminum shell
not available for seat width 30

BACKREST HEIGHT	34	40	52
Shell's shape	Lateral retaining wing R=regular		
	R	R	R
 	<input type="checkbox"/>	<input type="checkbox"/>	<input type="checkbox"/>
			

Configuration DEEP with side support PAD (height adjustable)

Alluminum lateral with padded, breathable upholstery.



Small (h 13cm)



Right
10272

Left
10272

Large (h 20cm)



Right
10273

Left
10273

Date Order User Address

Accessories

KID AIR POSTURE

SWING AWAY - Lateral support
Not available for backrest Physio AIR carbon shell
Fixing and adjustment hardware complete with protection sleeve
Alluminum lateral with padded, breathable upholstery.

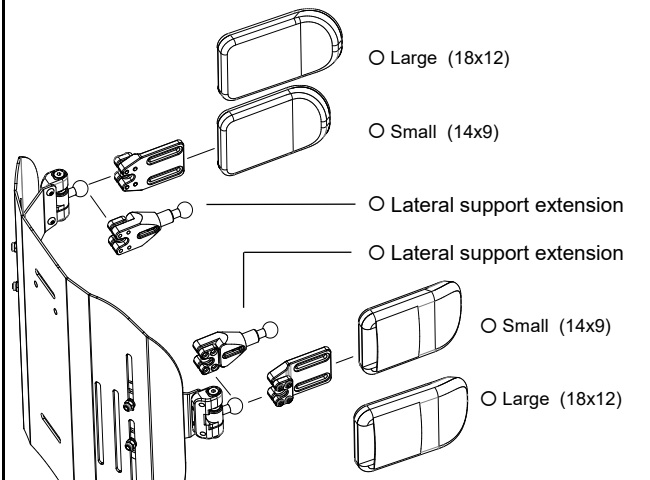

Large (18x12)

05647

Small (14x9)

05643

Lateral support extension

Quantity (number pcs).....

10271

Lateral support extension

Quantity (number pcs).....

Small (14x9)

05642

Large (18x12)

05646

Headrest adjustable - Double ball mounting system
Available only with backrest Physio Posture and Kid

Large (35x12,5)

05648

Small (25x12,5)



Empty section for additional notes or specifications.



Empty section for additional notes or specifications.

Send this page only if any optional have been chosen	
<input checked="" type="checkbox"/> standard	(supplied if no requests are indicated)
<input type="checkbox"/> on request	(without extra charge)
<input type="radio"/> optional	(cost to be added at the basic price)

Date	Order	User	Address
------------	-------------	------------	---------------

SMARTDRIVE - including battery charger



 <p>SWITCH CONTROL (DX+SX) - EU Funzionamento a due pulsanti</p>	<input type="radio"/> 6 KM/H MX2-S002 <input type="radio"/> 9 KM/H MX2-S005
 <p>SWITCH CONTROL + JACK 3.5 - EU "Mono" female input, allows SmartDrive to be connected to any other control/driving device.</p>	<input type="radio"/> 6 KM/H MX2-S003 <input type="radio"/> 9 KM/H MX2-S006

Pulsante di comando esterno BUDDY BUTTON
completo di adattatore, set di montaggio e braccio di estensione
Disponibile solo con SWITCH CONTROL + JACK 3.5





MX2-BBB

ATTACHMENT HARDWARE FIX FRAME KIT
Choose attachment hardware kit according to the size of the wheelchair's rear wheels

<input type="checkbox"/> Attachment hardware fix frame kit - rear wheels 22" - 24"	MX2-44S-C
<input type="checkbox"/> Attachment hardware fix frame kit - rear wheels 25"	MX2-45S-C
<input type="checkbox"/> Attachment hardware fix frame kit - rear wheels 26"	MX2-46S-C

SMART WATCH

Lo SmartDrive può essere comandato e gestito con uno Smart Watch APPLE o GALAXY
Fast and simple setup
Increased screen visibility
Improved battery performance
Free App from Apple Store and Play Store

<p><u>Lista compatibilita'</u></p> 	<p>Smart Watch compatibili</p> <p>APPLE WATCH serie 5 o successivi con iOS 8 o successivi Apple iPhone</p> <p>GALAXY WATCH serie 4 o successivi Smartphone Samsung Smartphone Android 6.0 e RAM almeno 1.5 GB</p>	<p>Applicazioni gratuite</p> <div style="display: flex; justify-content: space-around;"> <div style="text-align: center;"> <p>SmartDrive MX2+</p>  </div> <div style="text-align: center;"> <p>Pushtracker</p>  </div> </div>
--	--	---

Accessories

<input type="radio"/> Carrying bag	 <p style="margin-top: 10px;">MX2SD-BAG</p>
<input type="radio"/> Universal padded handle <i>Universal padded handle</i>	 <p style="margin-top: 10px;">MX2-986</p>

Wheelchair : Progeo EASY TILT - Rev. 2026.0	Prices - VAT excluded to be added to the price list	<p style="text-align: center; font-size: small;">Send this page only if any optional have been chosen</p> <table style="width: 100%; border-collapse: collapse;"> <tr> <td style="width: 10%; text-align: center;">★</td> <td style="width: 70%;">standard</td> <td style="width: 20%; text-align: right; font-size: x-small;">(supplied if no requests are indicated)</td> </tr> <tr> <td style="text-align: center;">□</td> <td>on request</td> <td style="text-align: right; font-size: x-small;">(without extra charge)</td> </tr> <tr> <td style="text-align: center;">○</td> <td>optional</td> <td style="text-align: right; font-size: x-small;">(cost to be added at the basic price)</td> </tr> </table>	★	standard	(supplied if no requests are indicated)	□	on request	(without extra charge)	○	optional	(cost to be added at the basic price)
★	standard	(supplied if no requests are indicated)									
□	on request	(without extra charge)									
○	optional	(cost to be added at the basic price)									