

Date User End user weight (kg) Language user manual	Progeo (English) Company stamp	Folding frame wheelchair Responsible
--	--	--

Wheelchair measures - The tolerance on all the dimensions indicated and/or required is ± 10 mm	
Seat width (LS) <input type="checkbox"/> 33 <input type="checkbox"/> 36 <input type="checkbox"/> 39 <input type="checkbox"/> 42 <input type="checkbox"/> 45 <input type="checkbox"/> 48 The seat width is measured from the outer sides of the frame For seat enlargement see section enlargement of mudguard and armrest with integrated mudguard	
Seat depth (PS) <input type="checkbox"/> 35 <input type="checkbox"/> 37,5 <input type="checkbox"/> 40 <input type="checkbox"/> 42,5 <input type="checkbox"/> 45 <input type="checkbox"/> 47,5 <input checked="" type="checkbox"/> 50	
Footplate distance (DP) (cm) ±0.5cm - adjustment steps 1.5cm (Real distance between seat and footplate) - IMPORTANT NOTICE! From the footplate to the floor minimum 4cm !! (Minimum Front height = DP + 4cm)	
Setting ☆ Standard <input type="checkbox"/> Prudential <input type="checkbox"/> Active <input type="checkbox"/> Extreme	
Backrest Height (TS) Std.Value 36(min 30-max 54) adjustment steps 1.5cm	
Crossbrace (black) ☆ Single <input type="checkbox"/> Double (Not seat width 33-36)	
Front height (STD 49) - Rear height (STD 44)	

Rear frame	
Aluminium frame	<div style="display: flex; align-items: flex-start;"> <div> <p>☆ Aluminium standard frame - Same colour of front frame</p> <p>The real seat depth, from the front part of the seat cloth to the backrest tube will be 1 cm more than the declared one.</p> <p>camber ☆ 0° <input type="checkbox"/> 1,5° <input type="checkbox"/> 3°</p> </div> </div>
	<div style="display: flex; align-items: flex-start;"> <div> <p><input type="radio"/> Aluminium frame DYNAMIC 2.0 - (COLOUR: BLACK) 09955</p> <p>The real seat depth, from the front part of the seat cloth to the backrest tube will be 1,5 cm more than the declared one.</p> <p>With rake adjustable backrest (±9°) Exclude the installation of : Brake handles for companion (Drum Brake)</p> <p>camber ☆ 0° <input type="checkbox"/> 1,5° <input type="checkbox"/> 2° <input type="checkbox"/> 4°</p> </div> </div>

Front frame	
<input type="checkbox"/> Short frame - Ideal with Seat depth (PS) 35 - 37,5 Not available for depth 45 - 47,5	
<input type="checkbox"/> Medium frame - Ideal with Seat depth (PS) 40 - 42,5 Not available for depth 47,5	
<input type="checkbox"/> Long frame - Ideal with Seat depth (PS) 45 - 47,5	Frame Angle ☆ 110° <input type="checkbox"/> 100°

Frame colour	
Frame colour (without extra charge)	
<input checked="" type="checkbox"/> Opaque black <input type="checkbox"/> Tekno anthracite <input type="checkbox"/> Matt grey <input type="checkbox"/> POLAR white <input type="checkbox"/> Matt Midnight blue <input type="checkbox"/> Matt red	
Frame colour on request	
<input type="radio"/> Bright silver <input type="radio"/> Bright fuchsia <input type="radio"/> Bright blue china 12579 <input type="radio"/> Bright blue <input type="radio"/> Bright lime <input type="radio"/> Bright red	

Backrest
☆ Adjustable velcro straps and padded transpiring upholstery

Handle tube	
☆ Tubes with standard handle	
<input type="checkbox"/> Folding handles Not available with: Push handles for companion, Brake handles for companion (Drum Brake)	02958

Date	Order	User	Address
------------	-------------	------------	---------------

Colour set: Includes rear wheel hub and rim, rear wheel plates and front forks
 Only standard Progeo 22"/24" wheels have coloured hubs and rims

<input checked="" type="checkbox"/> Black	22" 24" 25" 26"	
<input type="checkbox"/> Bright silver	22" 24"	00833
<input type="checkbox"/> Bright lime	22" 24"	00833
<input type="checkbox"/> Bright blue	22" 24"	00833
<input type="checkbox"/> Bright red	22" 24"	00833
<input type="checkbox"/> Bright fuchsia	22" 24"	00833
<input type="checkbox"/> POLAR white	22" 24"	00833
<input type="checkbox"/> Tekno anthracite	22" 24"	00833
<input type="checkbox"/> Matt Midnight blue	22" 24"	00833
<input type="checkbox"/> Matt grey	22" 24"	00833
<input type="checkbox"/> Matt red	22" 24"	00833

Casters

<input checked="" type="checkbox"/> 5" Soft		
<input type="checkbox"/> 4" Soft		
<input type="checkbox"/> 3" Sport	<i>Lightest configuration</i>	
<input type="checkbox"/> 6" Soft	(Available only with 110° angle)	
<input type="checkbox"/> 6" Pneumatic	(Available only with 110° angle)	
<input type="checkbox"/> 7" Soft	(Available only with 110° angle)	
<input type="checkbox"/> 3" Active Soft (wide)	(Aluminium alloy rim)	06824
<input type="checkbox"/> 4" Active Sport (narrow)	(Aluminium alloy rim)	01398
<input type="checkbox"/> 4" Active Soft (wide)	(Aluminium alloy rim)	03943
<input type="checkbox"/> 5" Active Soft (wide)	(Aluminium alloy rim)	07518
<input type="checkbox"/> 5" Pneumatic		10844

Rear wheels





<input checked="" type="checkbox"/> 24" Ultra-light Progeo - Standard!		
<input type="checkbox"/> 22" Ultra-light Progeo - Standard!		
<input type="checkbox"/> 25" Ultra-light Progeo - Standard!	(colour: black)	
<input type="checkbox"/> 26" Progeo - Standard!	(colour: black)	
<input type="checkbox"/> 24" ULTRA-LIGHT PROGEO KEY SPORT	<i>Lightest configuration</i>	04383
<input type="checkbox"/> 24" Ultra-light "Spinergy LX"		01685
<input type="checkbox"/> 24" Ultra-light "Spinergy LXL"	<input type="checkbox"/> Black hub and white spokes <input type="checkbox"/> Hub and spokes black	07846
<input type="checkbox"/> 24" Ultra-light "Spinergy Flex rim"	Integrated aluminium/rubber handrim	02270
<input type="checkbox"/> 25" Ultra-light "Spinergy LX"		02101
<input type="checkbox"/> 25" Ultra-light "Spinergy LXL"	<input type="checkbox"/> Black hub and white spokes	07847
<input type="checkbox"/> 26" Ultra-light "Spinergy LX"		02102
<input type="checkbox"/> 24" Off-road (aluminium handrim black - Wheel distance 4cm)		01392
<input type="checkbox"/> 24" with brake handles for companion (drum brake) (aluminium handrim - Wheel distance 3cm)		03384
Available only with camber 0°		
Not available with Frame Dynamic 2.0°		
<input type="checkbox"/> One arm drive - (24" rear wheels Aluminium handrim High pressure Tyre) - camber 0°	<input type="radio"/> Right <input type="radio"/> Left	02103







Rear wheel tyre



<input checked="" type="checkbox"/> High pressure tyre	(22"-24"-25"-26")	<i>Lightest configuration</i>	
<input type="checkbox"/> High pressure profile tyre	(24")		
<input type="checkbox"/> Marathon Plus	(24"-25")	with anti-puncture protection	01669
<input type="checkbox"/> Anti-puncture - Colour Black	(24")		11083
Not available with Rear wheels : 24" ULTRA-LIGHT PROGEO KEY SPORT, 24" Ultra-light "Spinergy LXL"			
<input type="checkbox"/> Anti-puncture - Colour Grey	(22")		04181

Date	Order	User	Address
------------	-------------	------------	---------------

Handrim	Wheel distance ☆ 3 cm □ 4 cm		
☆ Aluminium	(22"-24"-25"-26")	<i>Lightest configuration</i>	
<input type="checkbox"/> Aluminium black SOFT-TOUCH	(24"-25")	(24" handrim, on 25" wheel is installed with spacers)	09170
<input type="checkbox"/> Chromed Steel	(24"-25")	(24" handrim, on 25" wheel is installed with spacers)	01684
<input type="checkbox"/> Titanium	(24"-25")	(24" handrim, on 25" wheel is installed with spacers)	00016
<input type="checkbox"/> Ultra Grepp	(24"-25")	(24" handrim, on 25" wheel is installed with spacers)	00017
<input type="checkbox"/> TOP FRICTION Oval countour with a rubber insert	(24"-25")	(24" handrim, on 25" wheel is installed with spacers)	11023
<input type="checkbox"/> NOVA H Ergonomic black profile	(24"-25")	(24" handrim, on 25" wheel is installed with spacers)	11025
<input type="checkbox"/> NOVA D Ergonomic profile with rubber coating (ideal for quadripelgics)	(24"-25")	(24" handrim, on 25" wheel is installed with spacers)	11026
<input type="checkbox"/> Silicon cover for standard aluminium handrim		Available for measures (22" - 24" - 26")	04050

Wheel locks		
☆ Bent lever push to lock		
<input type="checkbox"/> Straight lever push to lock		
<input type="checkbox"/> Straight lever pull to lock		
<input type="checkbox"/> Sport brake		06428
<input type="checkbox"/> Brake with extension lever push to lock		01949
<input type="checkbox"/> Brake with extension lever pull to lock		03372

Footplate - See reference tables N°3		
☆ Plastic footrest, rake adjustable (Minimum footplate distance 33cm.)	☆ 2/3 Internal □ 2/3 External	 11525
<input type="checkbox"/> Automatic Closure footplate , rake and depth adjustable (Minimum footplate distance 30cm.)	<input type="checkbox"/> Internal ☆ 2/3 Internal □ External	 11526
○ Minimum footplate distance 25cm. Available only with Multi-function and rotative system - 03945 ,00		
<input type="checkbox"/> One piece footplate - Flip-up! rake and depth adjustable (Minimum footplate distance 30cm.)	<input type="checkbox"/> Internal ☆ 2/3 Internal □ External	 11527
○ Minimum footplate distance 25cm. Available only with Multi-function and rotative system - 03945 ,00		
<input type="checkbox"/> One piece aluminium footplate - Flip-up! rake and depth adjustable (Minimum footplate distance 30cm.)	<input type="checkbox"/> Internal ☆ 2/3 Internal □ 2/3 External □ External	 11528
<input type="checkbox"/> One piece Carbon fibre footplate rake adjustable, swing away, flip-up. (Minimum footplate distance 30cm.)	☆ Internal □ External	 03291
<input type="checkbox"/> Footplate COMPACT, automatic Closure, rake and depth adjustable Minimum footplate distance 35cm.	☆ Internal □ External	 09957

Mudguard		
Mudguard - FIXED		
☆ ABS mudguard		
<input type="checkbox"/> ABS Straight sideguard		 03946
<input type="checkbox"/> Carbon fibre mudguard		08918
<input type="checkbox"/> Carbon fibre Straight sideguard		
<input type="checkbox"/> Mudguard enlargement		
☆ + 0 cm		
<input type="checkbox"/> + 1 cm <input type="checkbox"/> + 2 cm	Not available with Rear wheels with brake handles for companion (Drum Brake)	12648
Mudguard - REMOVABLE		
<i>The distance between the two side guards is 1 cm wider than the seat width</i>		
<input type="checkbox"/> Removable ABS mudguard		08921
<input type="checkbox"/> Removable ABS fibre straight sideguard		08921
<input type="checkbox"/> Removable carbon fibre mudguard		08919
<input type="checkbox"/> Removable Carbon fibre straight sideguard		08920

Date	Order	User	Address
------	-------	------	---------

Armrests
Tubular armrests with standard support combined with anti-tipper wheels exclude the possibility of installing the transit wheels.

Tubular armrests (Swing away, removable and height adjustable armrest)
 Standard Support (Not with frame Dynamic)
 Steel support with safety locking system



04828

00694

Removable armrest with integrated mudguard

Desk armrests PROGEO (Removable and height adjustable)
 Not available with Frame Dynamic 2.0 + camber 4°



09956

Enlargement of Desk armrests PROGEO
 ☆ + 0 cm
 + 2 cm Available only with Ultra-light Progeo standard wheels and camber 0°



12648

Flip-up armrests PROGEO (Removable and height adjustable)
 Not available with Frame Dynamic 2.0



12277

Removable armrest with ABS straight sideguard
The distance between the two side guards is 1 cm wider than the seat width



08881

Removable armrest with carbon-fiber straight sideguard
The distance between the two side guards is 1 cm wider than the seat width



08882

Accessories

Pad for front frame protectors 07058

Backrest-seat connection cloth 10241

Removable storage bag (with quick coupling) 09811

Optional 1

Transit wheels 00836

Anti-tipper with rapid hookup (inside rotation to reduce the encumbrance)
 Right 00023
 Left 00024



Tipping aid Right 00025
 Left 01046



Crutches support Right 00838
 Left 00837



Optional 2

Tetraclip (Quick release axle for quadriplegic) 03947

Rear wheels plate extension (Not with frame Dynamic 2.0) 01950
 Handybike adaptor 00506

Push handles for companion (Removable and height adjustable) 01048



Harness 04103

Safety pelvic belt 03972

Tray table (removable) 00508

Lumbar support (to insert in the backrest upholstery) 00013

Super Head rest (Folding with the wheelchair) 04049



Swing away lateral support Right 02097
 Not available with Posture backrest PHYSIO Left 02098



Spoke guards Black (22"-24") 01043

Spoke guards Transparent (22"-24") 00835

Spoke guards Progeo design (22"-24") 00019

Additional Kit

24" Off-road rear wheels Off-Road tyre - aluminium handrim (black colour) 03378





24" FAT rear wheels FAT tyre 3" - aluminium handrim (black colour) 09357

Date Order User Address



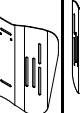
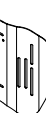

PHYSIO - Posture backrest - Std. Backrest upholstery not provided

Removable with quick release
Suitable for tubes with diameter 18÷26mm
Depth adjustment (4cm)
Angle adjustment (±18°)

- AIR** Carbon shell
not available for seat width 48

BACKREST HEIGHT	28	34	40			
Shell's shape  7.5 cm	Lateral retaining wing A=high - R=regular					
	A	R	A	R	A	R
						
	<input type="checkbox"/>	<input type="checkbox"/>	<input type="checkbox"/>	<input type="checkbox"/>	<input type="checkbox"/>	<input type="checkbox"/>

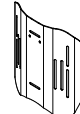
- POSTURE** Aluminum shell

BACKREST HEIGHT	34	40	52
Shell's shape  7.5 cm	Lateral retaining wing R=regular		
	R	R	R
			
	<input type="checkbox"/>	<input type="checkbox"/>	<input type="checkbox"/>

Configuration DEEP with side support PAD (height adjustable)

Alluminum lateral with padded, breathable upholstery.



Small (h 13cm)



Right
10272

Left
10272

Large (h 20cm)



Right
10273

Left
10273

SWING AWAY - Lateral support

Fixing and adjustment hardware complete with protection sleeve
Alluminum lateral with padded, breathable upholstery.

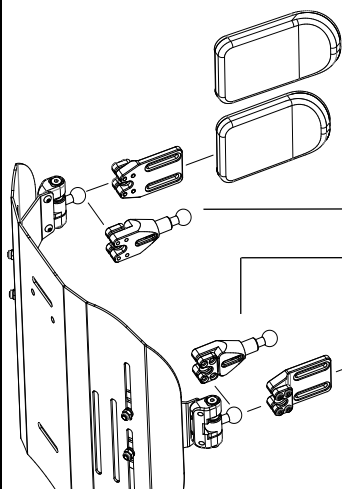

Large (18x12)

05647

Small (14x9)

05643

Lateral support extension

Quantity (number pcs).....

10271

Lateral support extension

Quantity (number pcs).....

Small (14x9)

05642

Large (18x12)

05646

- Headrest adjustable - Double ball mounting system
Available only with backrest Physio Posture

- Large (35x12,5)  05648
- Small (25x12,5)





Date	Order	User	Address
------------	-------------	------------	---------------

Note

Wheelchair : Progeo EXELLE - Rev. 2026.0	Prices - VAT excluded to be added to the price list	Send this page only if any optional have been chosen <input type="checkbox"/> standard (supplied if no requests are indicated) <input type="checkbox"/> on request (without extra charge) <input type="checkbox"/> optional (cost to be added at the basic price)
--	--	---

REFERENCE TABLES

1	Front height	
With closed frame (95°) max 5" caster		
Casters	Front height	
	min.	max
3"	41	52
4"	42	53
5"	44	54
6"	48	55
7"	50	56
The size of the fork will be defined only by Progeo in accordance with wheelchair final configuration.		

2	Rear height				
	Rear frame	Rear wheels			
		22"	24"	25"	26"
STANDARD	Straight plate 	min. 37 max 45	min. 39 max 47	min. 40 max 48	min. 41 max 49
	Shaped plate 	min. 36 max 49	min. 38 max 51	min. 39 max 52	min. 40 max 53
	Rear wheels plate extension with Tubular armrests 	min. 37 max 46	min. 39 max 48	min. 40 max 50	min. 41 max 51
DYNAMIC 2.0		min. 36 max 49	min. 38 max 51	min. 39 max 52	min. 40 max 53

3	Footplate option	Footplate distance	
		Frame Angle 110°	Frame Angle 100°
	Plastic footrest	min. 33	min. 31
	Automatic Closure footplate	min. 30	min. 28
	Automatic Closure footplate , with multifunction rotative system	min. 25	min. 23
	One piece footplate - Flip-up!	min. 30	min. 28
	One piece footplate - Flip-up! , with multifunction rotative system	min. 25	min. 23
	One piece aluminium footplate - Flip-up!	min. 30	min. 28
	One piece Carbon fibre footplate	min. 30	min. 28
Calculated with the best configuration and with the footplates positioned on inside.			
IMPORTANT NOTICE! From the footplate to the floor minimum 4cm !! (Minimum Front height = DP + 4cm)			

4	Rear wheels	
	Model	Features
	22" Ultra-light Progeo - Standard!	(not available in anthracite color)
	24" Ultra-light Progeo - Standard!	(available for all couloers)
	24" ULTRA-LIGHT PROGEO KEY SPORT	(silver hub, black rim and 16 spokes)
	24" Ultra-light "Spinergy LX"	(silver hub, black rim and spokes)
	24" Ultra-light "Spinergy LXL"	(black hub and rim, 18 white spokes) - (black hub, rim and 18 spokes)
	24" Ultra-light "Spinergy Flex rim"	(silver hub, black rim and spokes) - (integrated aluminium/rubber handrim - encumbrance reduction up to 3cm. - all tyre)
	24" Off-road	(colour: black) - (aluminium handrim - tyre Off-road)
	25" Ultra-light "Spinergy LX"	(silver hub, black rim and spokes)
	25" Ultra-light "Spinergy LXL"	(black hub and rim, 18 white spokes)
	26" Progeo - Standard!	(colour: black)
	26" Ultra-light "Spinergy LX"	(silver hub, black rim and 18 spokes)

Date	Order	User	Address
------	-------	------	---------

12" wheel - Motor 250W (750W maximum power)
14" wheel - Motor 1000W (1500W maximum power)

- Color display with switcher
- Maximum speed limit settable from display
- 5 speed levels selectable
- 10 display-selectable acceleration levels
- Adaptive Cruise Control
- Disc and electronic brake control lever
- Motor brake (adjustable in 10 levels from the display)
- Electronic brake with control bottom (adjustable in 10 levels from the display)
- Power regain when braking
- Error messages management from display (with error history)
- Rear gear beeper
- 48V - 5.8 Ah battery Autonomy up to 25km
- 48V - 11.6 Ah Power plus battery Autonomy up to 50km
- Battery charger 48V
- Rear gear
- USB port
- Easle
- Mudguard
- Front spoiler with predisposition for FULL LED light

(Certified software)

Mototronik

10979



Handlebar

☆ **STANDARD controls**

☆ Thumb accelerator

☆ Right
12592

Left
12593

Grip throttle

Right
10913

Left
10914

Disc and electronic brake control lever

☆ Right
12594

Left
12595

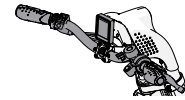

QUADRIPLEGIC controls
Handlebar PUSH&PULL



10905

☆ **MOTOTRONIK 12" wheel**

Motor 250W (750W maximum power)
Maximum speed according to law

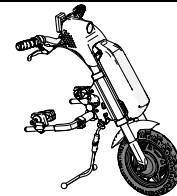

MOTOTRONIK 14" wheel

Motor 1000W (1500W maximum power)
Maximum speed according to law

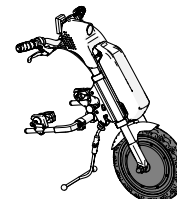

10903

Battery

☆ 48V - 5.8 Ah battery

Autonomy up to 25 km

48V - 11.6 Ah Power plus battery

Autonomy up to 50 km

10904

Date Order User Address

Accessories

- FULL LED light (high intensity)
 Integrated in the spoiler  10908

- Handlebar extension
 Adjustable from 15cm up to 23cm  10907

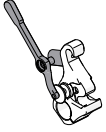
- Motor unit facilitated unlock lever
 Recommended with handlebar for quadriplegic  10915

- Additional FLY 48V - 2.9 Ah battery
 Autonomy up to 15km
 Approved for air transport 10906

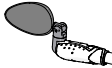
- Rearview mirror Right
 Left  10909
 10909

- Basket (removable) - (with KLICKfix® attachment system)  10912

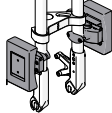
- Removable front weight - (with KLICKfix® attachment system)
 (it increases the weight over the power wheel to improve traction)  10910

- Travel bag 10916

Note

Send this page only if any optional have been chosen

- standard (supplied if no requests are indicated)
- on request (without extra charge)
- optional (cost to be added at the basic price)

Date	Order	User	Address
------------	-------------	------------	---------------

SMARTDRIVE - including battery charger



	<p>SWITCH CONTROL (DX+SX) - EU Funzionamento a due pulsanti</p>	<input type="radio"/> 6 KM/H	MX2-S002
		<input type="radio"/> 9 KM/H	MX2-S005



	<p>SWITCH CONTROL + JACK 3.5 - EU "Mono" female input, allows SmartDrive to be connected to any other control/driving device.</p>	<input type="radio"/> 6 KM/H	MX2-S003
		<input type="radio"/> 9 KM/H	MX2-S006

Pulsante di comando esterno BUDDY BUTTON
completo di adattatore, set di montaggio e braccio di estensione
Disponibile solo con SWITCH CONTROL + JACK 3.5





MX2-BBB

ATTACHMENT HARDWARE FOLDER KIT
Choose attachment hardware kit according to the size of the wheelchair's rear wheels

<input type="checkbox"/> Attachment hardware folder kit - rear wheels 22" - 24"	MX2-443-C
<input type="checkbox"/> Attachment hardware folder kit - rear wheels 25"	MX2-453-C
<input type="checkbox"/> Attachment hardware folder kit - rear wheels 26"	MX2-463-C

SMART WATCH

Lo SmartDrive può essere comandato e gestito con uno Smart Watch APPLE o GALAXY
 Fast and simple setup
 Increased screen visibility
 Improved battery performance
 Free App from Apple Store and Play Store

Lista <u>compatibilita'</u>	Smart Watch compatibili	Applicazioni gratuite	
	<p>APPLE WATCH serie 5 o successivi con iOS 8 o successivi Apple iPhone</p>	<p>SmartDrive MX2+ </p>	<p>Pushtracker </p>
	<p>GALAXY WATCH serie 4 o successivi Smartphone Samsung Smartphone Android 6.0 e RAM almeno 1.5 GB</p>		

Accessories

<input type="radio"/> Carrying bag	 MX2SD-BAG
<input type="radio"/> Universal padded handle <i>Universal padded handle</i>	 MX2-986

Wheelchair : Progeo EXELLE - Rev. 2026.0	Prices - VAT excluded to be added to the price list	<p style="text-align: center; font-size: small;">Send this page only if any optional have been chosen</p> <table style="width: 100%; border-collapse: collapse;"> <tr> <td style="width: 10%; text-align: center;">★</td> <td style="width: 60%;">standard</td> <td style="width: 30%; text-align: right; font-size: x-small;">(supplied if no requests are indicated)</td> </tr> <tr> <td style="text-align: center;">□</td> <td>on request</td> <td style="text-align: right; font-size: x-small;">(without extra charge)</td> </tr> <tr> <td style="text-align: center;">○</td> <td>optional</td> <td style="text-align: right; font-size: x-small;">(cost to be added at the basic price)</td> </tr> </table>	★	standard	(supplied if no requests are indicated)	□	on request	(without extra charge)	○	optional	(cost to be added at the basic price)
★	standard	(supplied if no requests are indicated)									
□	on request	(without extra charge)									
○	optional	(cost to be added at the basic price)									