

Date .....  
 User .....  
 End user weight (kg) .....  
 Language user manual .....

Progeo (English)  
Company stamp

Folding frame wheelchair

..... Responsible .....

**Wheelchair measures - The tolerance on all the dimensions indicated and/or required is ± 10 mm**

Seat width (LS)  36  39  42  45  48  
 The seat width is measured from the outer sides of the frame  
 For seat enlargement see section enlargement of mudguard and armrest with integrated mudguard

Seat depth (PS)  37,5  40  42,5  45  47,5  
 The real seat depth, from the front part of the seat cloth to the backrest tube will be 1 cm more than the declared one. - calculated with angle backrest 90° to the seat

Footplate distance (DP) ..... (cm) ±0.5cm - adjustment steps 1.5cm  
 (Real distance between seat and footplate) - IMPORTANT NOTICE! From the footplate to the floor minimum 4cm !! (Minimum Front height = DP + 4cm)

Setting  Standard  Prudential  Active  
 camber  2°  0°  4°  
 Backrest Height (TS) Std.Value 33,5 .....(min 24.5-max 47) adjustment steps 1.5cm  
 Backrest angle (to the seat)  90°  -6°  6°

Front height ..... (STD 49) - Rear height ..... (STD 43)

**Front frame**

Aluminium standard frame Angle 100°

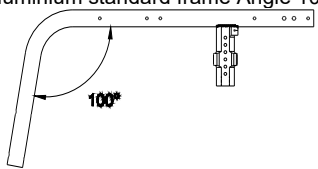

Short frame - Ideal with Seat depth (PS)37,5 - 40  
 Long frame - Ideal with Seat depth (PS)42,5 - 45 - 47,5

Aluminium frame Angle 90° - (max 5" caster)

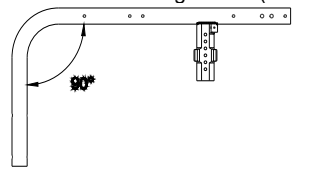

Short frame - Ideal with Seat depth (PS)37,5 - 40  
 Long frame - Ideal with Seat depth (PS)42,5 - 45 - 47,5

**Frame colour**

Opaque black  Tekno anthracite  Matt grey  
 POLAR white  Matt Midnight blue  Matt red  
 Matt orange

**Backrest**

Adjustable velcro straps and padded transpiring upholstery

**Handle tube**

Tubes with standard handle

Folding handles

Not available with: Push handles for companion, Brake handles for companion (Drum Brake)



02958

**Casters**

4" Soft  
 3" Sport *Lightest configuration*  
 5" Soft  
 6" Soft (Available only with 100° angle)  
 6" Pneumatic (Available only with 100° angle)  
 3" Active Soft (wide) (Aluminium alloy rim) 06824  
 4" Active Sport (narrow) (Aluminium alloy rim) 01398  
 4" Active Soft (wide) (Aluminium alloy rim) 03943  
 5" Active Soft (wide) (Aluminium alloy rim) 07518  
 5" Pneumatic 10844

**Support front fork**

Standard support front fork

Front fork support V Design 2.0  
 Exclude the installation of QUICK RELEASE FRONT FORKS



06850

Date ..... Order ..... User ..... Address .....

**Colour set: Includes rear wheel hub and rim, rear wheel plates and front forks**  
 Only standard Progeo 22"/24" wheels have coloured hubs and rims

<input checked="" type="checkbox"/> Black	22" 24" 25" 26"	
<input type="checkbox"/> Bright silver	22" 24"	00833
<input type="checkbox"/> Bright lime	22" 24"	00833
<input type="checkbox"/> Bright blue	22" 24"	00833
<input type="checkbox"/> Bright red	22" 24"	00833
<input type="checkbox"/> Bright fuchsia	22" 24"	00833
<input type="checkbox"/> POLAR white	22" 24"	00833
<input type="checkbox"/> Tekno anthracite	22" 24"	00833
<input type="checkbox"/> Matt Midnight blue	22" 24"	00833
<input type="checkbox"/> Matt grey	22" 24"	00833
<input type="checkbox"/> Matt red	22" 24"	00833

**Rear wheels**

<input checked="" type="checkbox"/> 24" Ultra-light Progeo - Standard!		
<input type="checkbox"/> 22" Ultra-light Progeo - Standard!		
<input type="checkbox"/> 25" Ultra-light Progeo - Standard!	(colour: black)	
<input type="checkbox"/> 26" Progeo - Standard!	(colour: black)	
<input type="checkbox"/> 24" ULTRA-LIGHT PROGEO KEY SPORT	<i>Lightest configuration</i>	04383
<input type="checkbox"/> 24" Ultra-light "Spinergy LX"		01685
<input type="checkbox"/> 24" Ultra-light "Spinergy LXL"	<input type="checkbox"/> Black hub and white spokes <input type="checkbox"/> Hub and spokes black	07846
<input type="checkbox"/> 24" Ultra-light "Spinergy Flex rim"	Integrated aluminium/rubber handrim	02270
<input type="checkbox"/> 25" Ultra-light "Spinergy LX"		02101
<input type="checkbox"/> 25" Ultra-light "Spinergy LXL"	<input type="checkbox"/> Black hub and white spokes	07847
<input type="checkbox"/> 26" Ultra-light "Spinergy LX"		02102
<input type="checkbox"/> 24" Off-road (aluminium handrim black - Wheel distance 4cm)		01392
<input type="checkbox"/> 24" with brake handles for companion (drum brake) (aluminium handrim - Wheel distance 3cm)		03384
<b>Available only with: camber 0° and Setting Standard</b>		
<input type="checkbox"/> One arm drive - (24" rear wheels Aluminium handrim High pressure Tyre) - camber 0°	<input type="checkbox"/> Right <input type="checkbox"/> Left	02103

**Rear wheel tyre**

<input checked="" type="checkbox"/> High pressure tyre	(22"-24"-25"-26")	<i>Lightest configuration</i>	
<input type="checkbox"/> High pressure profile tyre	(24")		
<input type="checkbox"/> Marathon Plus	(24"-25")	with anti-puncture protection	01669
<input type="checkbox"/> Anti-puncture - Colour Black	(24")		11083
<b>Not available with Rear wheels : 24" ULTRA-LIGHT PROGEO KEY SPORT, 24" Ultra-light "Spinergy LXL"</b>			
<input type="checkbox"/> Anti-puncture - Colour Grey	(22")		04181

Handrim	Wheel distance	<input checked="" type="checkbox"/> 3 cm <input type="checkbox"/> 4 cm	
<input checked="" type="checkbox"/> Aluminium	(22"-24"-25"-26")	<i>Lightest configuration</i>	
<input type="checkbox"/> Aluminium black SOFT-TOUCH	(24"-25")	(24" handrim, on 25" wheel is installed with spacers)	09170
<input type="checkbox"/> Chromed Steel	(24"-25")	(24" handrim, on 25" wheel is installed with spacers)	01684
<input type="checkbox"/> Titanium	(24"-25")	(24" handrim, on 25" wheel is installed with spacers)	00016
<input type="checkbox"/> Ultra Grepp	(24"-25")	(24" handrim, on 25" wheel is installed with spacers)	00017
<input type="checkbox"/> TOP FRICTION	(24"-25")	(24" handrim, on 25" wheel is installed with spacers)	11023
<b>Oval countour with a rubber insert</b>			
<input type="checkbox"/> NOVA H	(24"-25")	(24" handrim, on 25" wheel is installed with spacers)	11025
<b>Ergonomic black profile</b>			
<input type="checkbox"/> NOVA D	(24"-25")	(24" handrim, on 25" wheel is installed with spacers)	11026
<b>Ergonomic profile with rubber coating (ideal for quadriplegics)</b>			
<input type="checkbox"/> Silicon cover for standard aluminium handrim		Available for measures (22"- 24" - 26")	04050

**Wheel locks**

<input checked="" type="checkbox"/> Bent lever push to lock		
<input type="checkbox"/> Straight lever push to lock		
<input type="checkbox"/> Straight lever pull to lock		06428
<input type="checkbox"/> Sport brake		01949
<input type="checkbox"/> Brake with extension lever push to lock		03372
<input type="checkbox"/> Brake with extension lever pull to lock		

Date	Order	User	Address
------	-------	------	---------

**Footplate - See reference tables N°3**

☆ Automatic Closure footplate rake and depth adjustable  
 Minimum footplate distance 35cm.     Internal    ☆ 2/3 Internal     External  
 Minimum footplate distance 30cm. Available only with Multi-function and rotative system - 03945 ,00



11526

One piece footplate - Flip-up! rake and depth adjustable  
 Minimum footplate distance 35cm.     Internal    ☆ 2/3 Internal     External  
 Minimum footplate distance 30cm. Available only with Multi-function and rotative system - 03945 ,00



11527

One piece aluminium footplate - Flip-up! rake and depth adjustable  
 Minimum footplate distance 35cm.     Internal    ☆ 2/3 Internal     2/3 External     External



11528

Plastic footrest rake adjustable  
 Minimum footplate distance 35cm.    ☆ 2/3 Internal     2/3 External  
 Need a stretch calf band.  
**NOT AVAILABLE WITH FRONT FORK SUPPORT V DESIGN 2.0**

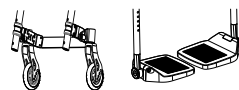

06861

One piece Carbon fibre footplate rake adjustable, swing away, flip-up.  
 Minimum footplate distance 35cm.     Internal     External



03291

Footplate COMPACT, automatic Closure, rake and depth adjustable  
 Minimum footplate distance 35cm.    ☆ Internal     External



09957

**Mudguard**

**Mudguard**  
 ☆ ABS mudguard  
 ABS Straight sideguard  
 Carbon fibre mudguard  
 Carbon fibre Straight sideguard



03946

**Mudguard enlargement**  
 ☆ + 0 cm  
 + 1 cm     + 2 cm    Not available with Rear wheels with brake handles for companion (Drum Brake)

08918

12648

**Removable version**  
*The distance between the two side guards is 1 cm wider than the seat width*  
 Removable ABS mudguard  
 Removable ABS fibre straight sideguard  
 Removable carbon fibre mudguard  
 Removable Carbon fibre straight sideguard



08921  
08921  
08919  
08920

**Armrests**

Tubular armrests - Steel support with safety locking system  
**(Swing away, removable and height adjustable armrest)**  
 Not available with anti-tippers if the rear seat height is less than 40cm



00694

**Removable armrest with integrated mudguard**

Desk armrests PROGEO (Removable and height adjustable)



09956

**Enlargement of Desk armrests PROGEO**  
 ☆ + 0 cm  
 + 2 cm    Available only with Ultra-light Progeo standard wheels and camber 0° or 2°

12648

Removable armrest with ABS straight sideguard  
*The distance between the two side guards is 1 cm wider than the seat width*



08881

Removable armrest with carbon-fiber straight sideguard  
*The distance between the two side guards is 1 cm wider than the seat width*

08882

**Accessories**

Pad for front frame protectors    07058





Backrest-seat connection cloth    10241

Removable storage bag (with quick coupling)    09811



Date .....	Order .....	User .....	Address .....
------------	-------------	------------	---------------

**Optional 1**

Only one optional devices for side can be chosen

<input type="checkbox"/> Transit wheels	Exclude the installation of : Anti-tippers - Tipping aid - Crutches support		00836
<input type="checkbox"/> Anti-tipper with rapid hookup	(inside rotation to reduce the encumbrance) <input type="checkbox"/> Right <input type="checkbox"/> Left		00023 00024
<input type="checkbox"/> Tipping aid	<input type="checkbox"/> Right <input type="checkbox"/> Left		00025 01046
<input type="checkbox"/> Crutches support	<input type="checkbox"/> Right		00838
	<input type="checkbox"/> Left		00837

**Optional 2**

<input type="checkbox"/> Tetraclip	(Quick release axle for quadriplegic)		03947
<input type="checkbox"/> Quick release front forks	To be matched only with: Standard support front fork		00030
<input type="checkbox"/> Push handles for companion	(Removable and height adjustable)		01048
<input type="checkbox"/> Safety pelvic belt			03972
<input type="checkbox"/> Harness			04103
<input type="checkbox"/> Lumbar support	(to insert in the backrest upholstery)		00013
<input type="checkbox"/> Swing away lateral support Not available with Posture backrest PHYSIO	<input type="checkbox"/> Right <input type="checkbox"/> Left		02097 02098
<input type="checkbox"/> Spoke guards Black	(22"-24")		01043
<input type="checkbox"/> Spoke guards Transparent	(22"-24")		00835
<input type="checkbox"/> Spoke guards Progeo design	(22"-24")		00019

**Additional Kit**







<input type="checkbox"/> 24" Off-road rear wheels	Off-Road tyre - aluminium handrim (black colour)		03378
<input type="checkbox"/> 24" FAT rear wheels	FAT tyre 3" - aluminium handrim (black colour)		09357

Date ..... Order ..... User ..... Address .....

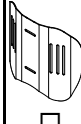
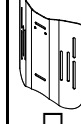

**PHYSIO - Posture backrest**  
(Std. Backrest upholstery not provided)

Removable with quick release  
Suitable for tubes with diameter 18÷26mm  
Depth adjustment (4cm)  
Angle adjustment (±18°)

**AIR** Carbon shell  
not available for seat width 48

BACKREST HEIGHT	28	34	40			
Shell's shape 	Lateral retaining wing A=high - R=regular					
	A	R	A	R	A	R
						
	<input type="checkbox"/>	<input type="checkbox"/>	<input type="checkbox"/>	<input type="checkbox"/>	<input type="checkbox"/>	<input type="checkbox"/>

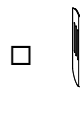
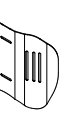
**POSTURE** Aluminum shell

BACKREST HEIGHT	34	40	52
Shell's shape 	Lateral retaining wing R=regular		
	R	R	R
			
	<input type="checkbox"/>	<input type="checkbox"/>	<input type="checkbox"/>

**Configuration DEEP with side support PAD (height adjustable)**

Alluminum lateral with padded, breathable upholstery.



Small (h 13cm)

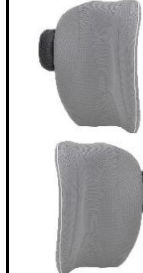

Right  
10272

Left  
10272

Large (h 20cm)



Right  
10273

Left  
10273

**SWING AWAY - Lateral support**

Fixing and adjustment hardware complete with protection sleeve  
Alluminum lateral with padded, breathable upholstery.

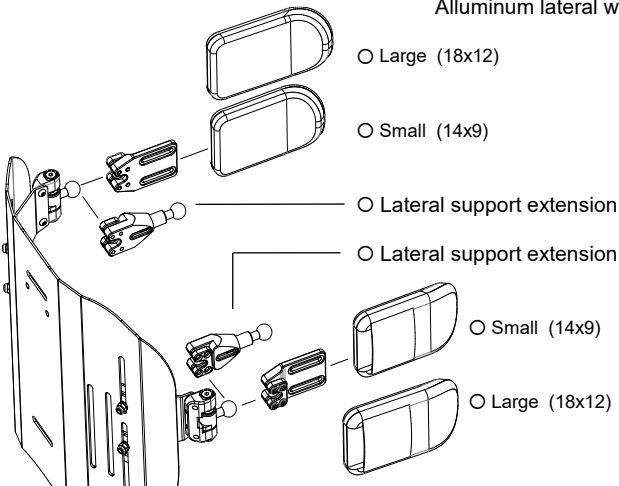

Large (18x12)

05647

Small (14x9)

05643

Lateral support extension

Quantity (number pcs).....

10271

Lateral support extension

Quantity (number pcs).....

Small (14x9)

05642

Large (18x12)

05646

Headrest adjustable - Double ball mounting system

Available only with backrest Physio Posture



Large (35x12,5)  
 Small (25x12,5)



05648

Date .....	Order .....	User .....	Address .....
------------	-------------	------------	---------------

**Note**

Wheelchair : Progeo TEKNA ADVANCE - Rev. 2026.0	Prices - VAT excluded to be added to the price list	<table border="1" style="width:100%; border-collapse: collapse;"> <tr> <td colspan="2" style="text-align: center;"><b>Send this page only if any optional have been chosen</b></td> </tr> <tr> <td style="text-align: center;">☆</td> <td>standard <small>(supplied if no requests are indicated)</small></td> </tr> <tr> <td style="text-align: center;">□</td> <td>on request <small>(without extra charge)</small></td> </tr> <tr> <td style="text-align: center;">○</td> <td>optional <small>(cost to be added at the basic price)</small></td> </tr> </table>	<b>Send this page only if any optional have been chosen</b>		☆	standard <small>(supplied if no requests are indicated)</small>	□	on request <small>(without extra charge)</small>	○	optional <small>(cost to be added at the basic price)</small>
<b>Send this page only if any optional have been chosen</b>										
☆	standard <small>(supplied if no requests are indicated)</small>									
□	on request <small>(without extra charge)</small>									
○	optional <small>(cost to be added at the basic price)</small>									

## REFERENCE TABLES

1	Front height			
With closed frame (95°) max 5" caster With closed frame (90°) max 5" caster With closed frame (85°) max 4" caster				
FORK	Casters			
	3"	4"	5"	6"
SMALL 	max 49	max 50	max 51	
MEDIUM 	max 53	max 54	max 55	max 57
The size of the fork will be defined only by Progeo in accordance with wheelchair final configuration.				

2	Rear height			
	Rear wheels			
	22"	24"	25"	26"
H min	min. 36	min. 38	min. 39	min. 40
H max	max 44	max 48	max 49	max 51

3	Footplate option	Footplate distance
	Automatic Closure footplate	min. 36
	Automatic Closure footplate , with multifunction rotative system	min. 31
	One piece footplate - Flip-up!	min. 36
	One piece footplate - Flip-up!, with multifunction rotative system	min. 31
	One piece aluminium footplate - Flip-up!	min. 36
	Plastic footrest	min. 36
	One piece Carbon fibre footplate	min. 36
Calculated with the best configuration and with the footplates positioned on inside. <b>IMPORTANT NOTICE! From the footplate to the floor minimum 4cm !! (Minimum Front height = DP + 4cm)</b>		

4	Rear wheels	
	Model	Features
	22" Ultra-light Progeo - Standard!	(not available in anthracite color)
	24" Ultra-light Progeo - Standard!	(available for all couloers)
	24" ULTRA-LIGHT PROGEO KEY SPORT	(silver hub, black rim and 16 spokes)
	24" Ultra-light "Spinergy LX"	(silver hub, black rim and spokes)
	24" Ultra-light "Spinergy LXL"	(black hub and rim, 18 white spokes) - (black hub, rim and 18 spokes)
	24" Ultra-light "Spinergy Flex rim"	(silver hub, black rim and spokes) - (integrated aluminium/rubber handrim - encumbrance reduction up to 3cm. - all tyre)
	24" Off-road	(colour: black) - (aluminium handrim - tyre Off-road)
	25" Ultra-light "Spinergy LX"	(silver hub, black rim and spokes)
	25" Ultra-light "Spinergy LXL"	(black hub and rim, 18 white spokes)
	26" Progeo - Standard!	(colour: black)
	26" Ultra-light "Spinergy LX"	(silver hub, black rim and 18 spokes)

Date .....	Order .....	User .....	Address .....
------------	-------------	------------	---------------

12" wheel - Motor 250W (750W maximum power)  
 14" wheel - Motor 1000W (1500W maximum power)

- Color display with switcher
- Maximum speed limit settable from display
- 5 speed levels selectable
- 10 display-selectable acceleration levels
- Adaptive Cruise Control
- Disc and electronic brake control lever
- Motor brake (adjustable in 10 levels from the display)
- Electronic brake with control bottom (adjustable in 10 levels from the display)
- Power regain when braking
- Error messages management from display (with error history)
- Rear gear beeper
- 48V - 5.8 Ah battery Autonomy up to 25km
- 48V - 11.6 Ah Power plus battery Autonomy up to 50km
- Battery charger 48V
- Rear gear
- USB port
- Easle
- Mudguard
- Front spoiler with predisposition for FULL LED light

**(Certified software)**

**Mototronik**

**10979**



**Handlebar**

☆ **STANDARD controls**

☆ Thumb accelerator

☆ Right  
12592

Left  
12593

Grip throttle

Right  
10913

Left  
10914

Disc and electronic brake control lever

☆ Right  
12594

Left  
12595

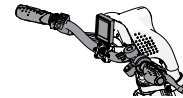

**QUADRIPLEGIC controls**  
 Handlebar PUSH&PULL

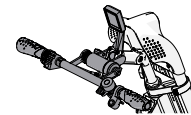

**10905**

☆ **MOTOTRONIK 12" wheel**

Motor 250W (750W maximum power)  
 Maximum speed according to law

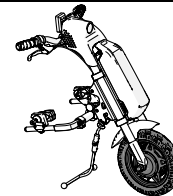

**MOTOTRONIK 14" wheel**

Motor 1000W (1500W maximum power)  
 Maximum speed according to law

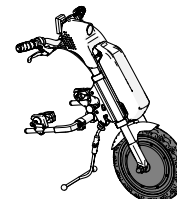

**10903**

**Battery**

☆ 48V - 5.8 Ah battery *Autonomy up to 25 km*

48V - 11.6 Ah Power plus battery *Autonomy up to 50 km*

**10904**

Date ..... Order ..... User ..... Address .....

### Accessories

FULL LED light (high intensity)  
Integrated in the spoiler



10908

Handlebar extension  
Adjustable from 15cm up to 23cm

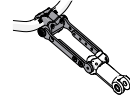

10907

Motor unit facilitated unlock lever  
Recommended with handlebar for quadriplegic

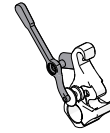

10915

Additional FLY 48V - 2.9 Ah battery  
Autonomy up to 15km  
Approved for air transport

10906

Rearview mirror

Right  
 Left

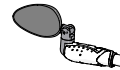

10909  
10909

Basket (removable) - (with KLICKfix® attachment system)



10912

Removable front weight - (with KLICKfix® attachment system)  
(it increases the weight over the power wheel to improve traction)

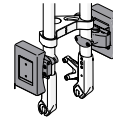

10910

Travel bag

10916

### Note

Send this page only if any optional have been chosen

Wheelchair : Progeo TEKNA ADVANCE - Rev. 2026.0

Prices - VAT excluded  
to be added to the price list

<input checked="" type="checkbox"/>	standard	(supplied if no requests are indicated)
<input type="checkbox"/>	on request	(without extra charge)
<input type="radio"/>	optional	(cost to be added at the basic price)

Date .....	Order .....	User .....	Address .....
------------	-------------	------------	---------------

**SMARTDRIVE - including battery charger**

**Attention not compatible one arm drive**



	<b>SWITCH CONTROL (DX+SX) - EU</b> Funzionamento a due pulsanti	<input type="radio"/> 6 KM/H	MX2-S002
		<input type="radio"/> 9 KM/H	MX2-S005

	<b>SWITCH CONTROL + JACK 3.5 - EU</b> "Mono" female input, allows SmartDrive to be connected to any other control/driving device.	<input type="radio"/> 6 KM/H	MX2-S003
		<input type="radio"/> 9 KM/H	MX2-S006

**Pulsante di comando esterno BUDDY BUTTON**  
 completo di adattatore, set di montaggio e braccio di estensione  
*Disponibile solo con SWITCH CONTROL + JACK 3.5*



MX2-BBB



**ATTACHMENT HARDWARE FOLDER KIT**  
 Choose attachment hardware kit according to the size of the wheelchair's rear wheels

<input type="checkbox"/> Attachment hardware folder kit - rear wheels 22" - 24"	MX2-443-C
<input type="checkbox"/> Attachment hardware folder kit - rear wheels 25"	MX2-453-C
<input type="checkbox"/> Attachment hardware folder kit - rear wheels 26"	MX2-463-C

**SMART WATCH**

Lo SmartDrive può essere comandato e gestito con uno Smart Watch APPLE o GALAXY

- Fast and simple setup
- Increased screen visibility
- Improved battery performance
- Free App from Apple Store and Play Store

<p><b>Lista <u>compatibilita'</u></b></p> 	<p><b>Smart Watch compatibili</b></p> <p><b>APPLE WATCH</b>                      serie 5 o successivi con iOS 8 o successivi                      Apple iPhone</p> <p><b>GALAXY WATCH</b>                      serie 4 o successivi                      Smartphone Samsung                      Smartphone Android 6.0 e RAM almeno 1.5 GB</p>	<p><b>Applicazioni gratuite</b></p> <div style="display: flex; justify-content: space-around;"> <div style="text-align: center;"> <p>SmartDrive MX2+</p>  </div> <div style="text-align: center;"> <p>Pushtracker</p>  </div> </div>
---	---	---

**Accessories**

Carrying bag

Universal padded handle  
*Universal padded handle*



MX2SD-BAG

MX2-986

Wheelchair : Progeo TEKNA ADVANCE - Rev. 2026.0	Prices - VAT excluded to be added to the price list	<p style="text-align: center; font-size: small;">Send this page only if any optional have been chosen</p> <table style="width: 100%; border-collapse: collapse;"> <tr> <td style="width: 10%; text-align: center;">★</td> <td style="width: 60%;">standard</td> <td style="width: 30%; text-align: right; font-size: x-small;">(supplied if no requests are indicated)</td> </tr> <tr> <td style="text-align: center;">□</td> <td>on request</td> <td style="text-align: right; font-size: x-small;">(without extra charge)</td> </tr> <tr> <td style="text-align: center;">○</td> <td>optional</td> <td style="text-align: right; font-size: x-small;">(cost to be added at the basic price)</td> </tr> </table>	★	standard	(supplied if no requests are indicated)	□	on request	(without extra charge)	○	optional	(cost to be added at the basic price)
★	standard	(supplied if no requests are indicated)									
□	on request	(without extra charge)									
○	optional	(cost to be added at the basic price)									