

Date	Order	User	Address
------------	-------------	------------	---------------

Rear wheels

- ☆ 24" Ultra-light Progeo - Standard!
- 22" Ultra-light Progeo - Standard!
- 25" Ultra-light Progeo - Standard! (colour: black)
- 26" Progeo - Standard! (colour: black)
- 24" ULTRA-LIGHT PROGEO KEY SPORT *Lightest configuration* 04383
- 24" Ultra-light "Spinergy LX" 01685
- 24" Ultra-light "Spinergy LXL" Black hub and white spokes Hub and spokes black 07846
- 24" Ultra-light "Spinergy Flex rim" Integrated aluminium/rubber handrim 02270
- 25" Ultra-light "Spinergy LX" 02101
- 25" Ultra-light "Spinergy LXL" Black hub and white spokes 07847
- 26" Ultra-light "Spinergy LX" 02102
- 24" Off-road (aluminium handrim black - Wheel distance 4cm) 01392

Rear wheel tyre

- ☆ High pressure tyre (22"-24"-25"-26") *Lightest configuration*
- High pressure profile tyre (24")
- Marathon Plus (24"-25") with anti-puncture protection 01669
- Anti-puncture - Colour Black (24") 11083
- Not available with Rear wheels : 24" ULTRA-LIGHT PROGEO KEY SPORT, 24" Ultra-light "Spinergy LXL"**
- Anti-puncture - Colour Grey (22") 04181

Handrim	Wheel distance ☆ 3 cm	□ 4 cm	
☆ Aluminium	(22"-24"-25"-26")		<i>Lightest configuration</i>
<input type="checkbox"/> Aluminium black SOFT-TOUCH	(24"-25")		(24" handrim, on 25" wheel is installed with spacers) 09170
<input type="checkbox"/> Chromed Steel	(24"-25")		(24" handrim, on 25" wheel is installed with spacers) 01684
<input type="checkbox"/> Titanium	(24"-25")		(24" handrim, on 25" wheel is installed with spacers) 00016
<input type="checkbox"/> Ultra Grepp	(24"-25")		(24" handrim, on 25" wheel is installed with spacers) 00017
<input type="checkbox"/> TOP FRICTION	(24"-25")		(24" handrim, on 25" wheel is installed with spacers) 11023
Oval countour with a rubber insert			
<input type="checkbox"/> NOVA H	(24"-25")		(24" handrim, on 25" wheel is installed with spacers) 11025
Ergonomic black profile			
<input type="checkbox"/> NOVA D	(24"-25")		(24" handrim, on 25" wheel is installed with spacers) 11026
Ergonomic profile with rubber coating (ideal for quadriplegics)			
<input type="checkbox"/> Silicon cover for standard aluminium handrim		Available for measures (22" - 24" - 26")	04050

Wheel locks

- ☆ Bent lever push to lock
- Straight lever push to lock
- Straight lever pull to lock
- Brake with extension lever push to lock
- Brake with extension lever pull to lock



01949
03372

Footplate - See reference tables N°3

- ☆ Automatic Closure footplate rake and depth adjustable
 - Internal ☆ 2/3 Internal External







Minimum footplate distance 32,5cm, calculated with the standard configuration and with the footplates positioned on inside.
 ○ Minimum footplate distance 25cm. Available only with Multi-function and rotative system - 03945 ,00
- One piece footplate - Flip-up! rake and depth adjustable
 - Internal ☆ 2/3 Internal External

Minimum footplate distance 32,5cm, calculated with the standard configuration and with the footplates positioned on inside.
 ○ Minimum footplate distance 26cm. Available only with Multi-function and rotative system - 03945 ,00
- One piece aluminium footplate - Flip-up! rake and depth adjustable
 - Internal ☆ 2/3 Internal 2/3 External External

Minimum footplate distance 32,5cm, calculated with the standard configuration and with the footplates positioned on inside.
- Plastic footrest rake adjustable
 - ☆ 2/3 Internal 2/3 External

Minimum footplate distance 34 cm, calculated with the standard configuration and with the footplates positioned on inside.
 Weight increase approx. 500gr.
 Need a stretch calf band.
- Footplate COMPACT, automatic Closure, rake and depth adjustable
 - Minimum footplate distance 35cm. ☆ Internal External
- One piece Carbon fibre footplate rake adjustable, swing away, flip-up.
 - ☆ Internal External

Minimum footplate distance 32,5cm, calculated with the standard configuration and with the footplates positioned on inside.

 11526
 11527
 11528
 11525
 09957
 03291

Date Order User Address

Mudguard

☆ ABS mudguard

Straight sideguard

Carbon fibre mudguard 03946

Extra charge for REMOVABLE VERSION 03960

Armrests

Tubular armrests (Swing away, removable and height adjustable armrest) 00694



Accessories

Pad for front frame protectors 07058

Backrest-seat connection cloth 10241

Removable storage bag (with quick coupling) 09811

Optional 1

Transit wheels 00836



Anti-tipper with rapid hookup (inside rotation to reduce the encumbrance)

Right 00023

Left 00024

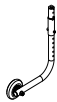

Tipping aid

Right 00025

Left 01046

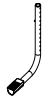

Crutches support

Right 00838

Left 00837



Optional 2

Tetraclip (Quick release axle for quadriplegic) 03947

Safety pelvic belt 03972

Harness 04103

Push handles for companion (Removable and height adjustable) 01048



Quick release front forks 00030

Lumbar support (to insert in the backrest upholstery) 00013

Spoke guards Black (22"-24") 01043

Spoke guards Transparent (22"-24") 00835

Spoke guards Progeo design (22"-24") 00019

Additional Kit

24" Off-road rear wheels Off-Road tyre - aluminium handrim (black colour) 03378

24" FAT rear wheels FAT tyre 3" - aluminium handrim (black colour) 09357

Date Order User Address

PHYSIO - Posture backrest

(Std. Backrest upholstery not provided)

Removable with quick release
Suitable for tubes with diameter 18+26mm
Depth adjustment (4cm)
Angle adjustment (±18°)

AIR Carbon shell

BACKREST HEIGHT	28	34	40			
Shell's shape  7,5 cm	Lateral retaining wing A=high - R=regular					
	A	R	A	R	A	R
	<input type="checkbox"/>	<input type="checkbox"/>	<input type="checkbox"/>	<input type="checkbox"/>	<input type="checkbox"/>	<input type="checkbox"/>

POSTURE Aluminum shell

BACKREST HEIGHT	34	40	52
Shell's shape  7,5 cm	Lateral retaining wing R=regular		
	R	R	R
	<input type="checkbox"/>	<input type="checkbox"/>	<input type="checkbox"/>

Configuration DEEP with side support PAD (height adjustable)

Alluminum lateral with padded, breathable upholstery.



Small (h 13cm)



Right
10272

Left
10272

Large (h 20cm)



Right
10273

Left
10273

SWING AWAY - Lateral support

Fixing and adjustment hardware complete with protection sleeve
Alluminum lateral with padded, breathable upholstery.

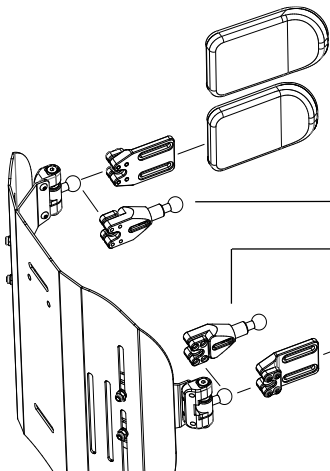

Large (18x12)

05647

Small (14x9)

05643

Lateral support extension

Quantity (number pcs).....

10271

Lateral support extension

Quantity (number pcs).....

Small (14x9)

05642

Large (18x12)

05646

Headrest adjustable - Double ball mounting system
Available only with backrest Physio Posture

Large (35x12,5)  05648



Small (25x12,5) 

Date	Order	User	Address
------------	-------------	------------	---------------

Note

Wheelchair : Progeo YOGA - Rev. 2026.1	Prices - VAT excluded <small>to be added to the price list</small>	<table border="1" style="width: 100%; border-collapse: collapse;"> <tr> <td colspan="2" style="text-align: center; padding: 2px;">Send this page only if any optional have been chosen</td> </tr> <tr> <td style="width: 10px; text-align: center; padding: 2px;">☆</td> <td style="padding: 2px;"> standard <small>(supplied if no requests are indicated)</small> </td> </tr> <tr> <td style="width: 10px; text-align: center; padding: 2px;">□</td> <td style="padding: 2px;"> on request <small>(without extra charge)</small> </td> </tr> <tr> <td style="width: 10px; text-align: center; padding: 2px;">○</td> <td style="padding: 2px;"> optional <small>(cost to be added at the basic price)</small> </td> </tr> </table>	Send this page only if any optional have been chosen		☆	standard <small>(supplied if no requests are indicated)</small>	□	on request <small>(without extra charge)</small>	○	optional <small>(cost to be added at the basic price)</small>
Send this page only if any optional have been chosen										
☆	standard <small>(supplied if no requests are indicated)</small>									
□	on request <small>(without extra charge)</small>									
○	optional <small>(cost to be added at the basic price)</small>									

REFERENCE TABLES

1		Front height			
FORK		Casters			
		3"	4"	5"	6"
SMALL 		min 43	min 44	min 46	
		max 44	max 45		
MEDIUM 		min 46	min 46	min 46	min 46
		max 47	max 48	max 49	max 51
LONG 		min 49	min 49	min 49	min 49
		max 50	max 51	max 52	max 53

The size of the fork will be defined only by Progeo in accordance with wheelchair final configuration.

2		Rear height			
		Rear wheels			
		22"	24"	25"	26"
H min		min. 40	min. 41	min. 42	min. 43
H max		max 47	max 49	max 50	max 51

3	Footplate option	Footplate distance	
	Automatic Closure footplate	min. 32.5	min. 32.5
	One piece footplate - Flip-up!	min. 32.5	min. 32.5
	One piece footplate - Flip-up! with multifunction rotative system	min. 27.5	min. 29
	One piece aluminium footplate - Flip-up!	min. 32.5	min. 32.5
	Plastic footrest	min. 34	min. 34
	One piece Carbon fibre footplate	min. 32.5	min. 32.5

Calculated with the standard configuration and with the footplates positioned on inside.

IMPORTANT NOTICE! From the footplate to the floor minimum 4cm !! (Minimum Front height = DP + 4cm)

4	Rear wheels	
	Model	Features
	22" Ultra-light Progeo - Standard!	(not available in anthracite color) - (aluminium handrim and high pressure tyre)
	24" Ultra-light Progeo - Standard!	(available for all colors)
	24" ULTRA-LIGHT PROGEO KEY SPORT	(silver hub, black rim and 16 spokes)
	24" Ultra-light "Spinergy LX"	(silver hub, black rim and spokes)
	24" Ultra-light "Spinergy LXL"	(black hub and rim, 18 white spokes) - (black hub, rim and 18 spokes)
	24" Ultra-light "Spinergy Flex rim"	(silver hub, black rim and spokes) - (integrated aluminium/rubber handrim - encumbrance reduction up to 3cm. - all tyre)
	24" Off-road	(colour: black) - (aluminium handrim - tyre Off-road)
	25" Ultra-light "Spinergy LX"	(silver hub, black rim and spokes)
	25" Ultra-light "Spinergy LXL"	(black hub and rim, 18 white spokes)
	26" Progeo - Standard!	(colour: black)
	26" Ultra-light "Spinergy LX"	(silver hub, black rim and 18 spokes)

Date	Order	User	Address
------------	-------------	------------	---------------

12" wheel - Motor 250W (750W maximum power)
 14" wheel - Motor 1000W (1500W maximum power)

- Color display with switcher
- Maximum speed limit settable from display
- 5 speed levels selectable
- 10 display-selectable acceleration levels
- Adaptive Cruise Control
- Disc and electronic brake control lever
- Motor brake (adjustable in 10 levels from the display)
- Electronic brake with control bottom (adjustable in 10 levels from the display)
- Power regain when braking
- Error messages management from display (with error history)
- Rear gear beeper
- 48V - 5.8 Ah battery Autonomy up to 25km
- 48V - 11.6 Ah Power plus battery Autonomy up to 50km
- Battery charger 48V
- Rear gear
- USB port
- Easle
- Mudguard
- Front spoiler with predisposition for FULL LED light

(Certified software)

Mototronik

10979



Handlebar

☆ **STANDARD controls**

☆ Thumb accelerator

☆ Right
12592

Left
12593

Grip throttle

Right
10913

Left
10914

Disc and electronic brake control lever

☆ Right
12594

Left
12595

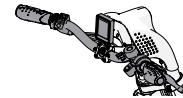

QUADRIPLEGIC controls
 Handlebar PUSH&PULL

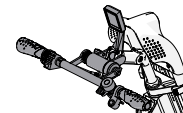

10905

☆ **MOTOTRONIK 12" wheel**

Motor 250W (750W maximum power)
 Maximum speed according to law

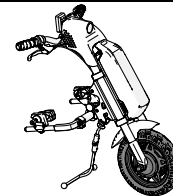

MOTOTRONIK 14" wheel

Motor 1000W (1500W maximum power)
 Maximum speed according to law

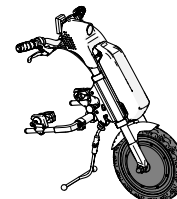

10903

Battery

☆ 48V - 5.8 Ah battery

Autonomy up to 25 km

48V - 11.6 Ah Power plus battery

Autonomy up to 50 km

10904

Date Order User Address

Accessories

FULL LED light (high intensity)
Integrated in the spoiler



10908

Handlebar extension
Adjustable from 15cm up to 23cm

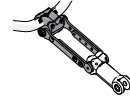

10907

Motor unit facilitated unlock lever
Recommended with handlebar for quadriplegic

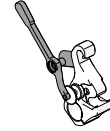

10915

Additional FLY 48V - 2.9 Ah battery
Autonomy up to 15km
Approved for air transport

10906

Rearview mirror

Right
 Left

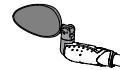

10909
10909

Basket (removable) - (with KLICKfix® attachment system)



10912

Removable front weight - (with KLICKfix® attachment system)
(it increases the weight over the power wheel to improve traction)

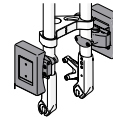

10910

Travel bag

10916

Note

Send this page only if any optional have been chosen

<input checked="" type="checkbox"/>	standard	(supplied if no requests are indicated)
<input type="checkbox"/>	on request	(without extra charge)
<input type="radio"/>	optional	(cost to be added at the basic price)

Date	Order	User	Address
------------	-------------	------------	---------------

SMARTDRIVE - including battery charger



	SWITCH CONTROL (DX+SX) - EU Funzionamento a due pulsanti	<input type="radio"/> 6 KM/H	MX2-S002
		<input type="radio"/> 9 KM/H	MX2-S005



SWITCH CONTROL + JACK 3.5 - EU	"Mono" female input, allows SmartDrive to be connected to any other control/driving device.	<input type="radio"/> 6 KM/H	MX2-S003
		<input type="radio"/> 9 KM/H	MX2-S006

Pulsante di comando esterno BUDDY BUTTON
 completo di adattatore, set di montaggio e braccio di estensione
Disponibile solo con SWITCH CONTROL + JACK 3.5

MX2-BBB

ATTACHMENT HARDWARE FOLDER KIT
 Choose attachment hardware kit according to the size of the wheelchair's rear wheels

<input type="checkbox"/> Attachment hardware folder kit - rear wheels 22" - 24"	MX2-443-C
<input type="checkbox"/> Attachment hardware folder kit - rear wheels 25"	MX2-453-C
<input type="checkbox"/> Attachment hardware folder kit - rear wheels 26"	MX2-463-C

SMART WATCH

Lo SmartDrive può essere comandato e gestito con uno Smart Watch APPLE o GALAXY
 Fast and simple setup
 Increased screen visibility
 Improved battery performance
 Free App from Apple Store and Play Store

Lista compatibilita'



Smart Watch compatibili

APPLE WATCH
 serie 5 o successivi con iOS 8 o successivi
 Apple iPhone

GALAXY WATCH
 serie 4 o successivi
 Smartphone Samsung
 Smartphone Android 6.0 e RAM almeno 1.5 GB

Applicazioni gratuite

SmartDrive MX2+



Pushtracker



Accessories

Carrying bag

Universal padded handle
Universal padded handle



MX2SD-BAG



MX2-986

Wheelchair : Progeo YOGA - Rev. 2026.1	Prices - VAT excluded to be added to the price list	<p style="text-align: center; font-size: small;">Send this page only if any optional have been chosen</p> <table style="width: 100%; border-collapse: collapse;"> <tr> <td style="width: 10%; text-align: center;">★</td> <td style="width: 60%;">standard</td> <td style="width: 30%; text-align: right; font-size: x-small;">(supplied if no requests are indicated)</td> </tr> <tr> <td style="text-align: center;">□</td> <td>on request</td> <td style="text-align: right; font-size: x-small;">(without extra charge)</td> </tr> <tr> <td style="text-align: center;">○</td> <td>optional</td> <td style="text-align: right; font-size: x-small;">(cost to be added at the basic price)</td> </tr> </table>	★	standard	(supplied if no requests are indicated)	□	on request	(without extra charge)	○	optional	(cost to be added at the basic price)
★	standard	(supplied if no requests are indicated)									
□	on request	(without extra charge)									
○	optional	(cost to be added at the basic price)									